

INSTRUCTION BOOK

for

MODEL SX-28-A

SUPER SKYRIDER RECEIVER

FREQUENCY RANGE — .55 to 43. MEGACYCLES

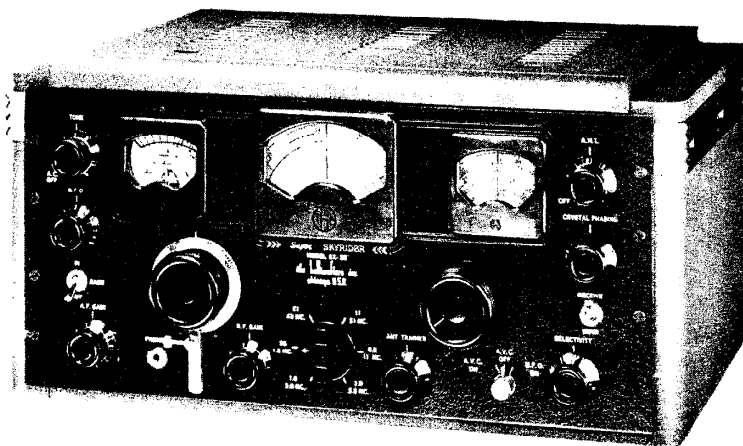

*the* hallicrafters *co.*

CHICAGO, ILL., U. S. A.

94X004

## TABLE OF CONTENTS

<i>Subject</i>	<i>Page</i>
TITLE PAGE .....	1
TABLE OF CONTENTS .....	2
A. Installation .....	4
1. Speaker .....	4
2. Antenna .....	4
3. Phono jack .....	4
4. DC power socket .....	4
5. "S" meter zero set .....	5
B. Operation .....	5
1. Bandswitch .....	5
2. Bandspread .....	5
3. Tone control .....	5
4. Send-Receive switch .....	5
5. R.F. Gain control .....	5
6. Antenna trimmer .....	5
7. A. F gain control .....	5
8. Selectivity control .....	6
9. Crystal Phasing control .....	6
10. Automatic noise limiter .....	6
11. "AVC BFO" switch .....	6
12. Bass "IN-OUT" switch .....	7
13. Head phone jack .....	7
C. Summary of related circuits .....	7
1. The 2 stage preselector .....	7
2. The oscillator and converter .....	7
3. The I F amplifier .....	7
4. Variable selectivity .....	7
5. Crystal filter circuit .....	8
5a Single signal adjustment .....	8
5b Crystal .....	8
6. Noise limiter .....	9
7. AVC action .....	11
8. "S" or signal intensity meter .....	11
9. The second detector .....	11
10. The beat frequency oscillator .....	11
11. The audio amplifier .....	11
12. The power supply .....	11
13. Specifications .....	11
D. Receiver Alignment .....	12
1. I. F. Alignment .....	12
2. BFO adjustment .....	12
3. Noise limiter and AVC amplifier adjustment .....	12
4. R F and OSC alignment .....	12

<i>Subject</i>	<i>Page</i>
E Table of tube socket voltages .....	16
F. Guarantee .....	16
G List of replaceable parts .....	17
H. Index to parts manufacturers .....	33
<b>I Drawings illustrations</b>	
Fig. 1—IF. Selectivity .....	6
Fig. 2—Crystal filter schematic .....	8
Fig. 3—Single signal operation .....	8
Fig. 4—Crystal selectivity .....	8
Fig. 5—Noise limiter schematic .....	9
Fig. 6—Noise limiter action .....	10
Fig. 7—AVC curve .....	10
Fig. 8—SX28-A Top view .....	13
Fig. 9—SX28-A Rear view .....	13
Fig. 10—Audio fidelity curve .....	14
Fig. 11—Audio filter curve .....	14
Fig. 12—RF and Oscillator adjustment location and alignment procedure .....	15
Fig. 13—SX28-A Schematic .....	34

## INSTRUCTION BOOK FOR MODEL SX-28-A SUPER SKYRIDER

### A INSTALLATION

It is recommended that, upon receipt, the carton and then the receiver be carefully examined for any damage which might have occurred in transit. Should any sign of damage be apparent immediately file claim with the carrier stating the extent of the damage.

**IMPORTANT:** Unless otherwise marked, the receiver is to be operated from 110-125 volts of 50/60 cycle alternating current. A universal 110-220 volt model is obtainable on order. This model can be operated at either of those two voltages with 50/60 cycle current. If the voltages are higher than indicated an external stepdown transformer must be used. A switch, mounted on the top of the universal transformer case, will allow convenient 110-220 voltage change.

The standard model SX-28-A receiver comes equipped with a cabinet for table mounting. The standard 8 $\frac{3}{4}$ " x 19" panel dimension with holes suitably spaced make it possible for the chassis to be mounted in a standard relay rack. Maximum overall chassis length is 17 $\frac{3}{8}$ " and depth 13 $\frac{1}{2}$ ". When the model SX-28-A is so mounted the table cabinet is replaced with a dust cover. The maximum over-all length of the receiver will then allow it to be mounted in a rack with upright channel clearance of 17 $\frac{1}{2}$ ".

### TERMINALS AND CONNECTIONS ON REAR OF RECEIVER

#### (1) SPEAKER

On the rear apron of the receiver's chassis appear two terminal strips for connecting either a 500 or 5000 ohm speaker to the receiver. Should a matching HALLICRAFTERS Bass-Reflex speaker be used with the receiver, it should be connected to the 5000 ohm terminals. The 500 ohm terminals can be connected to a speaker or other load of that impedance value.

#### (2) ANTENNA

To the terminals marked A1, A2 and G should be connected the antenna you have chosen to use with the model SX-28-A receiver.

Very satisfactory results throughout the tuning range of the SX-28-A will be obtained with a conventional inverted "L" Marconi type of antenna 75 to 100 feet long including lead-in. This antenna should be erected as high as possible and removed from surrounding objects. Be sure that the antenna is insulated from the ground at all points. When this type of antenna is used it is connected to terminal A-1. The Jumper between A 2 and G should remain connected.

In the event a doublet antenna is used with the model SX-28-A SUPER SKYRIDER receiver, the two wires of the doublet lead-in should be connected to terminals A1 and A2. The Jumper between A2 and G can remain connected or removed, depending upon its effect on favorable reception.

A ground can be used if desired and should be connected to the G terminal. Connecting the receiver to a good ground (cold water pipe or 6 foot rod driven in moist soil) might improve reception and reduce noise. Under normal conditions no noticeable difference will exist so a ground is suggested only if it aids reception.

Should you wish to have a separate antenna for some one short wave frequency or band, a half-wave antenna cut to the proper length for the desired frequency will prove very effective. The following formula will give the length of the  $\frac{1}{2}$  wavelength antenna depending on the desired frequency.

$$\text{Length in feet} = \frac{463}{\text{frequency in megacycles}}$$

or, for example, a half wave 40 meter antenna would be  $\frac{463}{7} = 66.14$  feet long

The antenna should preferably be of solid soft drawn enameled copper wire for ease in handling. The center of the wire is cut and an insulator inserted at that point. The twisted pair, or open wire transmission line, is then soldered to each 33 foot length, after the enamel has been scraped off, directly on either side of this center insulator. The other end of the transmission line should be connected to A1 and A2 on the receiver. It should be remembered that such an antenna has directional properties broadside to its length and should be so oriented if maximum pickup from a certain direction is to be expected.

In designing transmission line systems for a more accurate match of the line to the antenna input circuit, it will be helpful to know that the approximate antenna input impedance of the receiver is 400 ohms.

#### (3) PHONO-JACK

The Phono-Jack enables you to use the high fidelity audio amplifier of the receiver for phonograph record or transcription play-back purposes. A high impedance crystal or magnetic pick-up arm should be used for this purpose and connected to a standard headphone plug. This plug is then inserted in the PHONO-JACK when record playing is desired. The receiver is inoperative to radio signals, when the plug is in the phono-jack.

The volume of the audio amplifier is varied by rotating the AF Gain control until the proper level is obtained. Removal of the plug from the Phono-Jack once more places the RF and IF portions of the receiver in operation.

#### (4) DC POWER SOCKET

The octal socket on the rear of the chassis is used when it is necessary to furnish power to the receiver from a direct current source. For conventional AC operation, the shorting plug must remain in the DC OPERATION SOCKET. The shorting plug is removed for battery or vibrapack operation. A similar plug to the shorting plug is then wired, as shown in Fig. 13, and inserted in the octal socket.

A "B" supply capable of delivering 270 volts at 150 milliamperes is necessary for successful operation. Refer to the section on receiver specifications for the total battery drain for DC operation.

In addition to its function as connector for a DC supply, this socket also serves as an outlet for a remote

stand-by switch. If the remote stand-by switch or relay is connected between pins #1 and #5 on the shorting plug and the SEND-RECEIVE switch on the front panel of the receiver is set at SEND, the remote switch or relay will control the operation of the receiver in the same manner as the SEND-RECEIVE switch.

#### 5) "S" METER ZERO SET

"S" METER CONTROL is obtained by varying the knurled knob appearing on the left hand chassis apron edge. This control enables you to properly set the "S" Meter to zero. In order to make the adjustment correctly, the RF GAIN CONTROL must be advanced clockwise as far as it will go. In addition, the switch directly below the bandspread hand-wheel must be in the AVC-ON Position. When these conditions have been complied with, remove the antenna from the Receiver and then adjust the S meter control until the S meter reads zero. Reconnecting the antenna to the receiver will then make the meter indicate the relative carrier strength of each incoming signal as various signals are tuned in.

### B OPERATION

Each control of the Model SX 28 A SUPER SKYRIDER receiver performs a definite function that contributes to the outstanding reception capabilities of the unit. Full appreciation of the receiver is to be expected only after you have become familiar with each of the controls and the effect their operation has on the receiver's performance.

The large calibrated main dial shows the frequencies covered throughout the 6 band, 550 kc to 43 mc frequency range of the receiver. They are as follows:

Band 1—	550 to 1,600 kilocycles
Band 2—	1.6 to 3.0 megacycles
Band 3—	3.0 to 5.8 megacycles
Band 4—	5.8 to 11.0 megacycles
Band 5—	11.0 to 21.0 megacycles
Band 6—	21 to 43 megacycles

(1) The BANDSWITCH, directly below the main dial, will place the proper set of coils in the circuit to cover the desired frequency. The main dial is turned by the large handwheel which is equipped with a micrometer scale for maximum accuracy in resetting or logging purposes. Of particular interest is the locking clutch which will be found directly below the handwheel. This feature will allow you to lock the main dial after a desired signal has been tuned in. Subsequent movement of the handwheel will not detune the receiver because the control is provided with a clutch which disengages the handwheel once the dial lock has been set.

The International Shortwave broadcast bands are indicated on the main dial by heavier lines showing the frequencies on which these transmissions will be heard.

The Amateur band setting positions of the main dial are indicated by a small O appearing over the red numbers which identify each amateur band. The hairline on the main dial window should be set so that it intersects this small circle when the main dial is placed in position for the desired amateur band.

(2) The BANDSPREAD dial is calibrated for the 10-20-40 and 80 meter amateur bands. When tuning on the 160 meter band the main dial should be used.

Note: The calibration on the main dial will be accurate

only if the bandspread condenser is set at minimum capacity which is indicated by a setting of 100 on the bandspread logging scale. It should be recognized that if the bandspread condenser is left at any other setting but 100, that small amount of bandspread condenser capacity, added to the main tuning condenser capacity, would throw off the main tuning dial calibration because the receiver is calibrated with the Bandspread condenser set at minimum capacity. The portions of the amateur bands on which type A3, or telephone, transmissions will be heard are underscored with another dark line.

The numbered outer edge of the bandspread dial will prove to be of great help for logging or pre-setting purposes when the bandspread tuning control is used for easier tuning on frequencies other than those covered by the amateur bands.

When "bandspreading" any frequency throughout the tuning range of the receiver remember the main dial must then be set to a slightly higher frequency than the desired signal. The difference depends on the amount of bandspread condenser capacity used and the frequency of the received signal.

When switching from one range to another, an indicator moves vertically behind both the main and bandspread dials. Tuning fatigue is thereby greatly minimized by focusing attention on only the frequencies covered by that particular setting of the bandswitch.

The translucent, indirectly lighted dials are easily read and so arranged that parallax is reduced to an absolute minimum.

To operate the receiver adjust the following controls in the order in which they are mentioned:

(3) The TONE CONTROL turns the receiver on and off and in addition emphasizes either the base or treble frequencies to the extent required by various receiving conditions. The effect the Tone Control has on the fidelity of reproduction is shown in Fig. 10.

(4) Place the SEND-RECEIVE switch in the RECEIVE position—have the ANL control off (turned to the left until the switch operates).

Place the bandswitch in position 55 to 1.65 mc, which will then enable you to tune in stations on the standard Broadcast Band.

(5) Rotate the RF GAIN control to the right until #9 on the skirt of the control appears under the panel marker. (The RF Gain must be full ON as above indicated before the S meter will indicate correctly.) So that the S meter will be properly connected in the circuit, the AVC-BFO switch appearing to the lower right of the bandspread handwheel, must be in the AVC ON position.

(6) Note: The Antenna Trimmer control is operated on all Bands. Proper adjustment of this control is indicated by the maximum signal.

(7) After complying with the above conditions, the AF GAIN control should be advanced to the right until the desired volume is obtained. Tuning the receiver by operating the main dial handwheel will now allow you to pick up stations throughout the 55 to 1.65 mc tuning range of the Broadcast band. Maximum deflection of the S Meter will indicate when each station is accurately tuned in.

When covering the short-wave or higher frequency bands the above procedure should be followed—except that greater care should be used because it is so easy to completely pass over a station.

The other controls on the model SX-28-A SUPER SKYRIDER receiver will enable you to obtain the best results.

from the receiver once you have become used to their effects on the reception of various types of signals

(8) The SELECTIVITY control acts as a shutter or gate and varies the width of the path on which signals reach the second detector of the receiver. Six different selectivity steps are provided so that you can successfully cope with different degrees of interference. Reference to Fig 1 and Fig. 4 will show, graphically, how the control trims the width of the signal so that what interference might be present in the signal's skirts or sidebands is effectively clipped off. Should an interfering signal lap over into the desired signal, adjustment of the SELECTIVITY control, will reduce that interference.

FIG. 1—I. F. SELECTIVITY

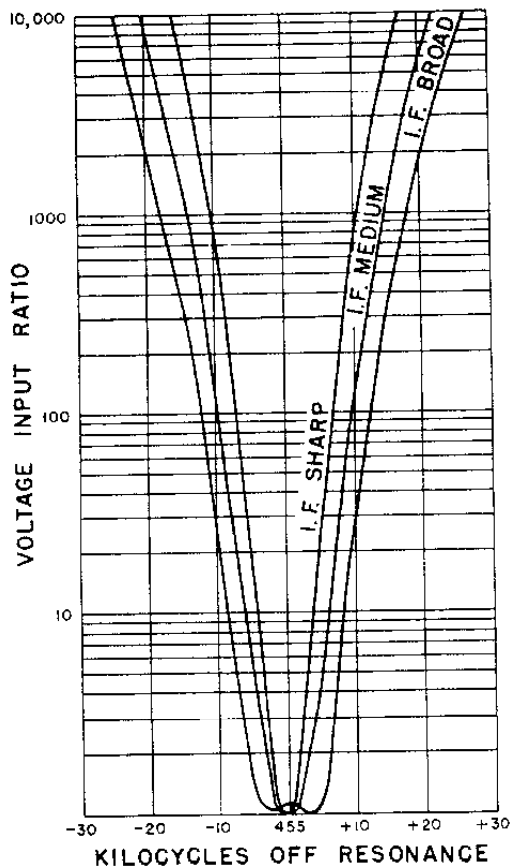

Once more refer to Fig 1 and Fig 4 and recognize the fact that with the control set in the BROAD IF position, the signal proper and all its parts, which are combined in the side bands, or skirts, will be passed to the 2nd detector, audio amplifier, and then Speaker. As the selectivity of the receiver is increased from BROAD-IF to XTALSHARP, the gate, or admittance path, is so narrowed that only the main portion of the signal is allowed to pass through. This fact and its effect on the quality of reproduction is readily appreciated by listening to a signal and noting the reduction in higher frequency response in the more selective settings of the switch. (See Fig 10 and Fig 11)

At this point, it is suggested that the CRYSTAL SHARP setting be used only in cases of extreme interference—the receiver must then be tuned exactly to the signal. Only then will the signal be intelligible because you have clipped off its sidebands in which the sibilants and overtones are embodied.

The CRYSTAL SHARP position of the selectivity switch is to be used principally for the reception of code, or CW, signals. By proper associated operation of the CRYSTAL PHASING control true single signal operation and the maximum in selectivity can be obtained (crystal circuit discussed in detail in the summary of related circuits.) See Fig 3.

#### (9) CRYSTAL PHASING CONTROL

The Phasing Control is in the circuit on three positions of the selectivity control namely—XTAL Sharp, XTAL Medium and XTAL Broad.

The control is used to remove heterodyne interference as well as to minimize other forms of interference having a predominance of high frequency components—such as static and interference from electrically operated devices.

(10) The A N L, or Automatic Noise Limiter, materially contributes to the satisfactory operation of the receiver by limiting objectionable interference caused by ignition systems or other man made causes of electrical disturbances. With the A N L control retarded to the left as far as it will go, or until the A N L switch is heard to operate—the noise limiter circuit is not functioning. Turning the control to the right closes the switch which is mounted on the control. The noise limiter is now operating. Progressively turning the control clockwise varies the threshold at which the noise limiter starts to take hold. The setting at which the control will be left depends entirely on the type and amount of interference present as well as the signal strength. The noise limiter should be judiciously adjusted because through its operation the desired signal can even be eliminated or badly distorted which destroys its usefulness. Only after you have become familiar with the operation of this control by actual practice can you determine how far it should be advanced before the best compromise between noise and signal is obtained. (See Fig 6)

(11) The AVC-BFO OFF-ON switch performs a dual function. The AVC circuit should be operating for the reception of telephone, or modulated signals in order to reduce fading to a minimum. As previously mentioned, the functioning of the S Meter is dependent upon AVC action so the switch must be in the AVC ON position when the S meter is used to measure relative carrier intensity.

Inasmuch as the AVC circuit levels all signals to a predetermined value (See Fig 7) no one signal can overload the receiver and cause distortion. At times in searching for distant or weak signals, it might be desirable to use the full sensitivity of the Model SX-28-A. In that case place the AVC switch in the AVC OFF position. Remember that with the receiver operating with no AVC action, strong signals will overload the input circuit with resultant distortion. Under such a condition of operation the sensitivity of the set must be then controlled, manually, by properly retarding the RF Gain control until you have reached the point below which overloading takes place.

The other function of this switch is to turn on the Beat Frequency oscillator. When receiving code signals, a beat note is absolutely essential. With the BFO switch in the ON position, each signal tuned in will be accompanied with a beat note or whistle. For proper adjust-

ment of the BFO control which appears directly under the TONE CONTROL the following procedure is suggested. Set the BFO control to zero, now tune in a signal either voice or code. If a code signal is received, only the carrier or thump of the signal will be audible because no beat note is present. Be sure that you have the signal accurately resonated. Now, without retuning the receiver, rotate the BFO control until a beat note of the desired pitch is obtained. You now have introduced a beat note which differs from the IF frequency of the receiver, namely 455 kc, by the frequency of the audible signal. Variation of the BFO control will allow you to change the pitch, or frequency, of the oscillator which will prove to be of help under various conditions of interference.

(12) Directly under the BFO control will be seen the BASS IN-OUT Switch. With this switch in the BASS IN position you will have normal audio fidelity. Placing the switch in the BASS OUT position, the audio filter CH<sub>2</sub> is inserted. The effect of this filter on the band of frequencies passed is shown Fig. 11. This filter will contribute greatly to the intelligibility of the received signal when the receiver is operated in the advanced positions of selectivity.

(13) The Head Phone Jack is connected to a tap on the output transformer. The signal in the headphones is of the proper volume for satisfactory communications reception. Since no direct current is present in the headphone circuit crystal type phones can be used.

C

## SUMMARY OF RELATED CIRCUITS

### (1) THE 2-STAGE PRESELECTOR

The RF AMPLIFIER, or pre-selector, of the Model SX-28-A SUPER SKYRIDER has 1-6AB7, 1-6SK7 tubes in cascade on Bands 3, 4, 5, and 6. On Bands 1 and 2 more than one stage is unnecessary to obtain the required image ratio and reduction of spurious interference. With two RF stages using three pre-selection circuits, the band width would be narrowed to such an extent that even expanding the IF Amplifier to its utmost would still not provide high-fidelity reception. The modern communications receiver requires two stages of preselection on the higher frequencies to accomplish only one primary object—satisfactory image rejection.

The Model SX-28-A has an image ratio of 20 to 1 at 28 mc—350 to 1 at 14 mc and a proportionately increasing ratio as the frequency is lowered. While the two RF stages are principally needed to obtain such image ratios they also perform two other useful functions—more favorable signal to noise ratio and slightly increased selectivity.

Examining the coil assembly will immediately show how rigidly it is constructed and what care has been taken to completely shield each section from the other. The manner in which the RF and antenna coils are tuned on bands 3, 4, 5, and 6 will be interesting. Rather than push turns to compensate for variations in inductance, each coil is permeability tuned. This results in exact adjustment of inductance with improved tracking and gain as the result. On Bands 1 and 2 the inductance of the antenna coils is sufficiently large so that lead length differences do not cause any noticeable inductance change.

### (2) THE OSCILLATOR AND CONVERTER

A separate 6SA7 tube is used as the High Frequency Oscillator in the Model SX-28-A SUPER SKYRIDER. This tube proves desirable in this function because of its very high value of transconductance which enables the oscillator to operate with very little coupling to the coil. This feature reduces the unfavorable effects of tube variations and voltage fluctuations on the tuned circuit. The HF Oscillator is coupled to the 6SA7 converter tube at the Cathode Tap—a point where variations of operating parameters of the converter tube will least affect the 6SA7 Oscillator. A 6SA7 tube is used in the Mixer Circuit because tests indicated that changes in operating voltages caused less reflection in the injector grid loading than would occur in most converter tubes. Another feature in favor of the 6SA7 tube is that a negative loading is

applied to the tuned circuit feeding its control grid. This characteristic improves the gain and selectivity of the tuned circuit which in turn improves the image and signal to noise ratio.

### (3) THE IF AMPLIFIER

The IF Amplifier of the Model SX-28-A was designed with a view towards permanency of adjustment under conditions of extreme changes in temperature and humidity as well as unusual mechanical vibration.

The first two IF Transformers are permeability tuned. In comparing this type of transformer with one having compression mica tuning condensers, it must be remembered that it takes many more turns of the adjusting screw to cause the equivalent change in tuning of the permeability tuned type. Hence a slight change in the position of the screw will have negligible effect upon the tuning. The adjusting screw is under spring tension thereby making it impossible to turn under vibration.

The diode transformer is air-tuned with two variable condensers each with a lump capacity of 50 mmf and variable of 50 mmf. These air trimmers are also under spring tension so that they can withstand considerable vibration. Being of the air-tuned type, their capacity change is negligible with wide changes in humidity. Reference to the Schematic will show that the IF transformers are expanded in two steps—thereby enabling medium or full reproduction of the higher frequencies to be obtained.

### (4) VARIABLE SELECTIVITY

Six ranges of selectivity are provided in the Model SX-28-A receiver. They are:

- 1—Broad IF—(for high fidelity reception)
- 2—Medium IF—(more selectivity—less highs)
- 3—Sharp IF—(reduces annoying interference—far less highs)
- 4—Crystal Broad—(Similar to Sharp IF but cleaner cutting of side bands)
- 5—Crystal Medium—(next selectivity step to #4—greatly increased sideband cutting—more pronounced crystal "slot" for interference—very little highs present)
- 6—Crystal Sharp—(position of extreme selectivity—practically no sideband content—very pronounced crystal "slot")

The graphic effects of the different steps of selectivity on a signal are shown in Fig. 1 and Fig. 4.

FIG. 2—CRYSTAL FILTER SCHEMATIC

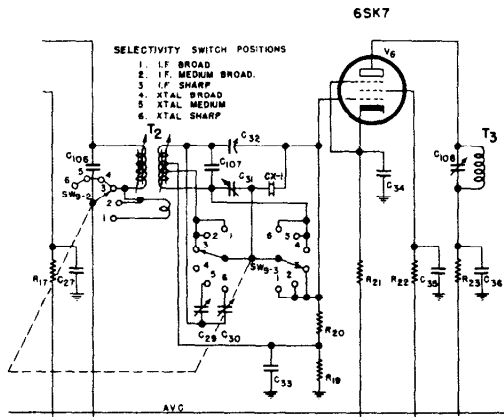

(5) CRYSTAL FILTER CIRCUIT

In positions 1, 2, 3 the crystal is short circuited. In position 4 the short across the crystal is opened and the iron core in the secondary of the transformer is adjusted for Broad Crystal Action and at this point is accurately tuned to the crystal frequency. Due to the close coupling of the secondary to the crystal, the sharply rising resonance curve of the crystal causes, in contrast, a sharply falling resonance curve in the secondary. The combined action of these two characteristics results in a relatively broad resonance curve for the CRYSTAL BROAD selectivity setting. In the MEDIUM CRYSTAL No. 5 position, C<sub>29</sub> is adjusted for selectivity midway between the BROAD and CRYSTAL SHARP settings. (See Fig. 2 and Fig. 4)

In position 6, or CRYSTAL SHARP, the trimmer C<sub>30</sub> is adjusted for the Sharpest crystal action. Under this condition, the Secondary is slightly detuned from the resonant crystal frequency sufficiently so that its resonance curve is not greatly affected by the crystal but still coupled tightly enough so that it can transfer energy to the crystal circuit. When this point is reached it is indicated by a rise in the output. Two such points of increased output will normally occur—one for each adjustment of the secondary on either side of the resonant frequency of the crystal.

(5a)

SINGLE SIGNAL ADJUSTMENT

It is extremely simple to attain single signal reception with the SX-28-A. First, turn on the BFO to the desired Beat Note and turn the selectivity switch to the XTAL SHARP position. Pick a good solid CW signal, preferably a commercial station because a commercial is likely to stay on long enough for you to complete the phasing adjustment for single signal reception.

You will find on tuning across this signal that it has two amplitudes. Tune first to the weaker of these two amplitudes. Now, turn the PHASING control until this weaker of the two amplitudes is reduced to a minimum. (If the weaker amplitude appears on the right the above procedure still holds.) Then tune to stronger of the two amplitudes and adjust the BFO control to a tone most pleasing to you. This adjustment for single signal selectivity will hold with no further adjustment unless you change the phasing control. (See Fig. 3.)

FIG. 3—SINGLE SIGNAL OPERATION

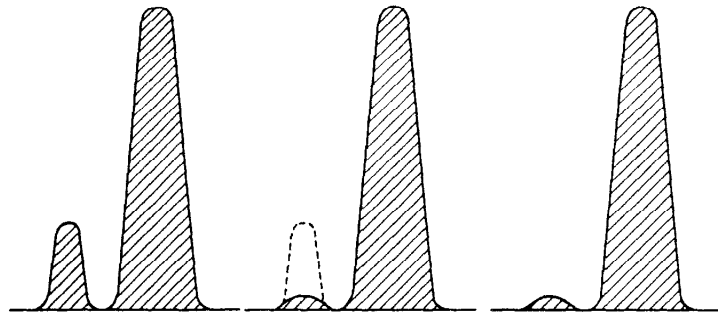

With Selective Switch in XTAL Sharp position identify the weaker amplitude—Tune Receiver to the weaker.

Adjust phasing control carefully until this weaker amplitude is reduced to a minimum.

Retune Receiver to the stronger amplitude and then adjust pitch control until you get note most pleasing to copy.

FIG. 4—CRYSTAL SELECTIVITY

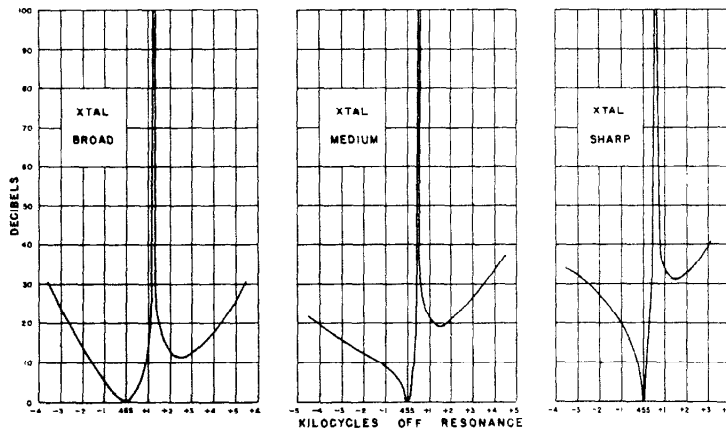

(5b)

CRYSTAL

The CRYSTAL FILTER and holder are wired directly into the receiver and do not plug in as heretofore. In this manner exceptional crystal filter action is obtained because of the elimination of the capacity and losses of a socket. So mounting the crystal prevents possible change in polarity which would occur if the crystal were improperly inserted in the circuit. The size of the crystal has been carefully determined to allow the BROAD CRYSTAL position to tune as broadly as possible. The capacity of the crystal holder has been reduced to a minimum through the use of a specially designed polystyrene holder.



(6)

### NOISE LIMITER

The principle of operation of the limiter is very similar to that of the Lamb limiter which has been described in detail in past issue of OST. The carrier of the received signal is first converted over to the intermediate frequency and then fed into the 6L7 amplifier and 6B8 AVC amplifier and 6AB7 noise amplifier. A broadly tuned IF transformer is used in the plate of the 6B8 with its primary and secondary closely coupled. The secondary feeds into the 6B8 diode where rectification of the carrier furnishes AVC voltage for the RF and mixer tube as well as for the 6AB7 noise amplifier. A broadly tuned IF transformer is used in the plate of the 6AB7, the secondary feeding into the 6H6 noise rectifier. A 455 kc wave trap (CH4 and C55) is used which allows the passage of the higher audio frequencies without attenuation. In the form of further explanation of our approach toward noise elimination, it must be remembered that noise in

general is composed of a random mixture of high and low frequencies. Of this mixture the predominating higher frequencies are the most objectionable. It is to our advantage to retain the high frequency components. Thus, these transients will be allowed to rise to a point far above the carrier level with the result that they will be applied to the injector grid of the 6L7 tube without being reduced in value. Transients, such as ignition interference having a steep wave front, consist largely of high frequency components. The voltage applied to the grid of the 6L7 tube has a negative polarity because of the 6H6 noise rectifier. By varying the ANL control, we raise or lower the negative voltage applied to the 6L7 tube until it is barely sufficient to overcome the noise impulses applied to the grid of this tube without allowing the modulation peaks of the carrier to become badly distorted.

FIG. 5—NOISE LIMITER SCHEMATIC

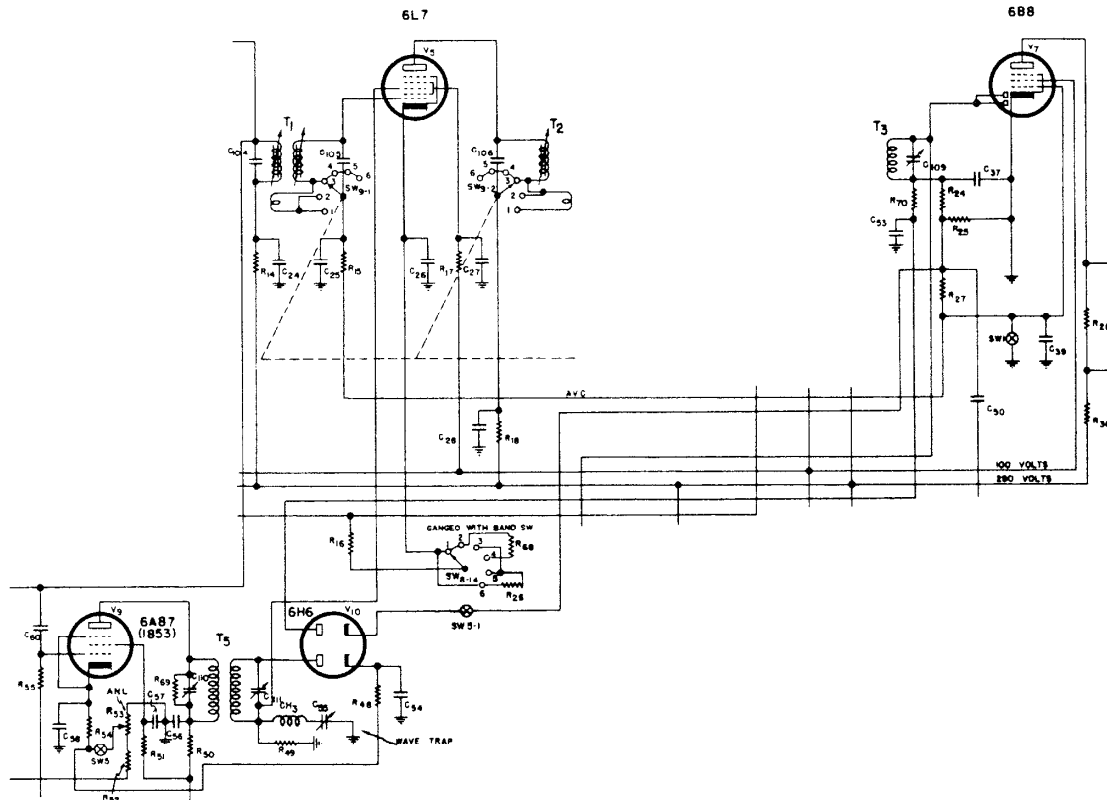
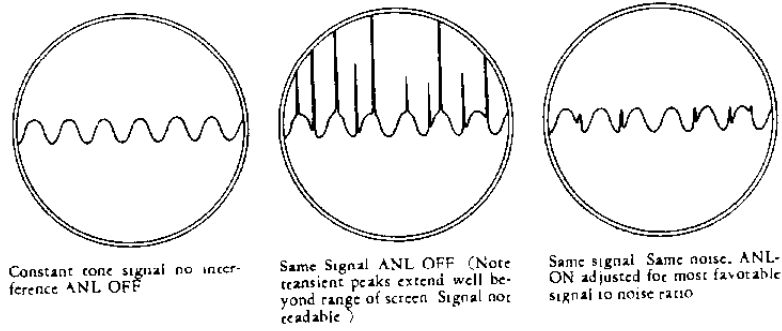

FIG. 6—NOISE LIMITER ACTION



If the noise limiter adjustment permits too great a value of transient voltage to be applied to the 6L7 injector grid, detection will take place and rectified components of this modulated carrier will appear in the 6L7 plate circuit. This effect will appear as distortion in the output of the receiver. If, on the other hand, not enough

noise voltage is applied, then the momentary decrease in sensitivity will not be great enough to stop the noise from getting through and some of it will appear in the plate circuit of the 6L7 tube and consequently in the output of the receiver. As a result the noise limiter must be carefully adjusted to the particular carrier and noise level being received. (See Fig. 6)

FIG. 7—A.V.C. CURVE—AT 3 MC.

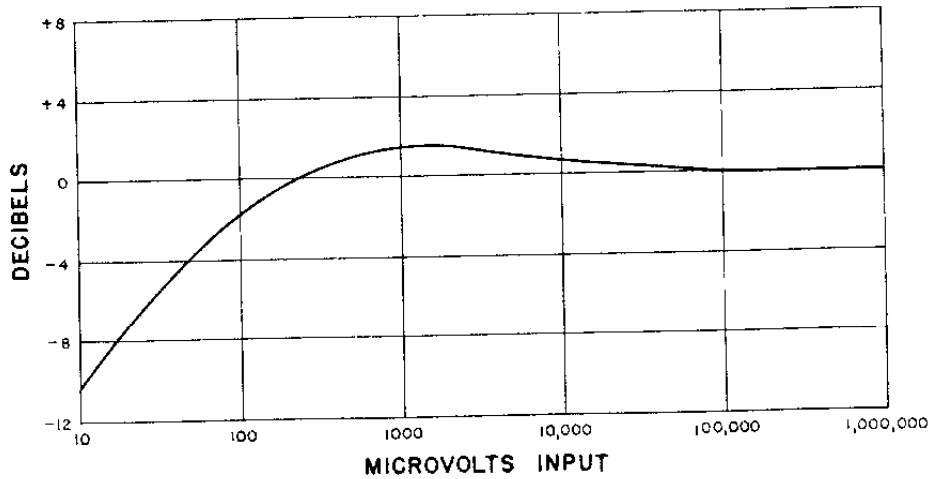

(7) **AVC ACTION**

A double AVC system is used. The RF and mixer tubes are operated by the broadly tuned carrier coming through only three tuned IF circuits. The final signal however passes through six-tuned IF circuits. As a result, when the signal is slightly detuned, the receiver output has dropped considerably while the AVC action has dropped but very little. This results in a reduction of between-station noise and a more sharply defined aural tuning action.

(8) **"S" OR SIGNAL INTENSITY METER**

The approximate DB per S unit equivalent is 6 DB's. As is known, a DB, or decibel, is a unit of change in signal level and is defined as being the least detectable change the average ear can appreciate when listening to a single pitched tone. 3DB is the least change the ear detects when listening to sounds varying in both amplitude and pitch. By comparison, a variation of one S unit on the meter will indicate a change of two detectable steps in signal level. Quantitatively, a DB gain or loss is equal to  $20 \log_{10} \left( \frac{E_1}{E_2} \right)$  where  $E_1$  = input voltage and  $E_2$  = output voltage.

(9) **THE SECOND DETECTOR**

As will be noted, a diode type of second detector is used in the Model SX-28-A. Its choice was prompted by the fact that such a detector is capable of handling large percentages of modulation with very little distortion. This is due to the output of the diode being easily filtered (IF Removed). In addition, the rectified output contains a DC component which can be used for AVC purposes.

(10) **THE BEAT FREQUENCY OSCILLATOR**

The BFO is turned on with the switch below the hand-spread handwheel and adjusted by the skirted knob directly below the tone control. The BFO circuit, as will be seen by referring to Fig. 13, is the well known Hartley oscillator. It will be noticed that a plate dropping resistor is used to compensate for plate voltage variations. An increase in receiver voltage causes an increase in the plate current of the oscillator. This increase in turn causes the voltage drop across the resistor to increase, thus maintaining a more constant voltage at the plate of the beat oscillator tube. A favorable ratio of capacity to inductance is used. The fixed tank capacity has been artificially aged by alternately exposing it to very high and then low temperatures. In this manner any residual strains of the component parts are removed and the capacity of the condenser remains constant. The BFO coil is permeability tuned which further removes the possibility of drift which would occur should a compression variable be used to resonate the circuit.

Proper location of the Beat Oscillator tube and its associated components plus excellent shielding and mechanical rigidity do much to keep stray fields from being established. Little BFO leakage is to be expected in the Model SX-28-A so "tweets" or BFO harmonics will not prove to be bothersome.

(11) **THE AUDIO AMPLIFIER**

The second or output stage of the audio amplifier in the Model SX-28-A receiver uses two 6V6GT tubes connected in push-pull. These tubes are driven by the 6SC7 double triode. One of the triode sections of the 6SC7 tube is used as the inverter to the 6V6GT tubes. A portion of the signal from the plate circuit of the first 6SC7

triode is fed to the grid of the other 6SC7 triode section, thereby giving two output voltages in opposite phase suitable for exciting the push-pull 6V6GT output amplifier.

(12) **THE POWER SUPPLY**

The power supply in the Model SX-28-A is quite normal except that it supplies voltage for the 6V6GT output tubes directly from the rectifier or before the filter system. Voltage fluctuations in the receiver are greatly reduced—increasing the audio output of the receiver and stabilizing the operation of all circuits.

The filter circuit consisting of a total of 60 mfd of capacity plus an additional filter in the 6SC7 plate supply and a 12 henry choke keep the hum level of the receiver in excess of 60 DB below maximum output. The power transformer is built to withstand continuous operation at 250 degrees F but has been designed to run at approximately 160 degrees F under normal conditions.

(13) **SPECIFICATIONS**

**Tubes:**

- 1 - 6AB7 1st RF Amplifier
- 1 - 6SK7 2nd RF Amplifier
- 1 6SA7 Mixer
- 1 6SA7 HF Oscillator
- 1 6L7 1st IF Amplifier Noise Limiter
- 1 6SK7 2nd IF Amplifier
- 1 6B8 2nd Detector and S meter tube
- 1 6B8 AVC Amplifier
- 1 6AB7 Noise Amplifier
- 1 6H6 Noise Rectifier
- 1 6J5 Beat Oscillator
- 1 6SC7 1st Audio Amplifier
- 2-6V6GT Push-Pull Output Amplifiers
- 1-5Z3 Rectifier

Power Consumption—ac 117 volts 60 cycles 138 watts  
Power Consumption DC operation 18 amp at 6 volts or 108 watts

Power Output —8 watts undistorted

Sensitivity—(for 500 milliwatts output) varies between the limits of 6 to 20 microvolts over the entire frequency range of the receiver.

	2 x	1000 x
Selectivity- IF broad (high selectivity)	12 kc	36 kc
IF Sharp	41 kc	22 kc

Frequency Range RF—Note: These are the actual frequencies covered corresponding to nominal figures indicated on the front panel.

- 550 to 1.620 kilocycles
- 1.5 to 3.1 megacycles
- 2.9 to 5.9 megacycles
- 5.75 to 11.5 megacycles
- 10.3 to 21.5 megacycles
- 20.4 to 45 megacycles

Frequency response AF (audio filter out—broad IF—tone control high) .70 to 3000 cycles  $\pm$  2½ DB

Speaker Output Impedances—5000 and 500 ohms

Intermediate Frequency—455 kc

Table cabinet dimensions—20½" long x 10" high x 14¼" deep

Relay Rack dust cover dimensions - 14¼" deep x 17¼" long x 8¾" high

Panel dimensions 19" x 8¾"

Chassis dimensions—17½" x 13½"

Weight—(unpacked)—75 lbs (packed 87 lbs)

## RECEIVER ALIGNMENT

D

### Equipment Needed for Aligning:

1—An all wave signal generator which will provide an accurately calibrated signal at the test frequencies indicated

2—Output indicating meter connected to 5000 ohm output terminals.

3—Non-metallic screw driver

4—Dummy antenna of 200 mmf and also 400 ohm carbon resistor

Setting of controls prior to alignment—IF and RF

Tone control at maximum high frequency position (#9)—BFO at 0—Bass switch at Bass IN—AF Gain at #9—RF Gain at #9—Band switch—IF alignment position 55 to 1.6 band—RF alignment depending on band aligned.

Selectivity control at sharp IF—Send-Receive switch in Receive—Crystal phasing at #3 on left side—ANL—OFF at 0—AVC OFF

**Important:** Have bandspread control so logging scale reads 100.

Antenna trimmer adjusted for Maximum gain at each RF alignment point on all bands.

- (1) **455 KC—IF Alignment:** Tune main dial to 1400 kc on .55 to 1.6 mc band. Connect the hot lead from the signal generator to 6SA7 mixer terminal #8—Ground to chassis. Roughly adjust the aligning screws of T1, the lower screw of which is accessible through hole in right mounting bracket, for maximum gain. Now adjust lower screw on T2 (do not adjust upper screw). Also adjust C31 and the air trimmer condensers at the top of T3 for maximum gain. (See Fig. 8 for location of IF adjustments)

Switch to Crystal Broad Position—Turn on BFO and adjust to a tone of about 1000 cycles. Vary the frequency of the signal generator while adjusting the top screw on T2 until the output goes through a maximum, dips down and starts going up again. Adjust the phasing control for maximum selectivity and then back off the top screw on T2 until the output reaches a minimum value between the two maximum values first noted. The frequency of the signal generator should be varied over a small range while adjusting the top screw of T2. A swishing note, in contrast to the usual sharp crystal tone will be ap-

parent when the correct adjustment has been reached.

Switch to 'Xtal Sharp' and adjust C-10 for maximum output while varying signal generator frequency. Two points of maximum output will be noted corresponding to two adjustments of C-10. Either one of these points may be used at which to leave C-10, a sharply peaked tone will result at the correct adjustment.

Switch to 'Xtal Medium' and adjust C-29 till the output is midway between the outputs reached while aligning the 'Xtal Sharp' and 'Xtal Broad' positions. The apparent sharpness of tone should be midway between the 'Sharp' and 'Broad' positions.

Switch again to 'Xtal Sharp' and set the signal generator to exact crystal frequency. Set BFO front panel control to a tone of approximately 1000 cycles. Switch again to 'Sharp IF' and carefully realign the IF transformers as earlier described in the first paragraph of these instructions.

- (2) **BFO Adjustment:** Set front panel control to zero. BFO switch ON—Signal Generator tuned to crystal frequency. Selectivity switch in IF Sharp position—now, adjust screw on top of T4, after loosening lock nut, to zero best. (See Fig. 8)
- (3) **Noise Limiter and AVC Amplifier Adjustment:** Have the controls set as before except that the AVC switch is now in the ON position. Connect a high resistance type voltmeter across R49 which is connected between terminal #5 of the 6L7 tube and chassis. Connect a 50,000 ohm resistor across primary of T5 (Red and Blue leads). Set generator at 455 kc as for IF alignment. Connect generator to grid of 6AB7 tube (pin #4). Rotate ANL control all the way to the right, or position #9. Adjust screws on top of T5 for maximum indication on DC meter connected across R49. Reconnect generator, as for IF alignment, to mixer grid of 6SA7 tube. Remove 50,000 ohm resistor which was inserted across primary of T5 during alignment. Remove grid clip off top of 6L7 tube. With generator set at 455 kc and ANL control at extreme right adjust wave trap trimmer C55 for minimum signal as indicated on output meter. (See Fig. 8 and Fig. 12 for location of adjustments)
- With generator connected to 6SA7 mixer grid as above, replace 6L7 grid and turn ANL control to extreme left until switch clicks. Connect high resistance DC meter across 6B8 diode filter condenser C64. Adjust screw on top of T6 for maximum indication on DC meter across C64.
- (4) For RF and oscillator adjustment location and alignment procedure see Fig. 12

FIG. 8—SX28-A—TOP VIEW

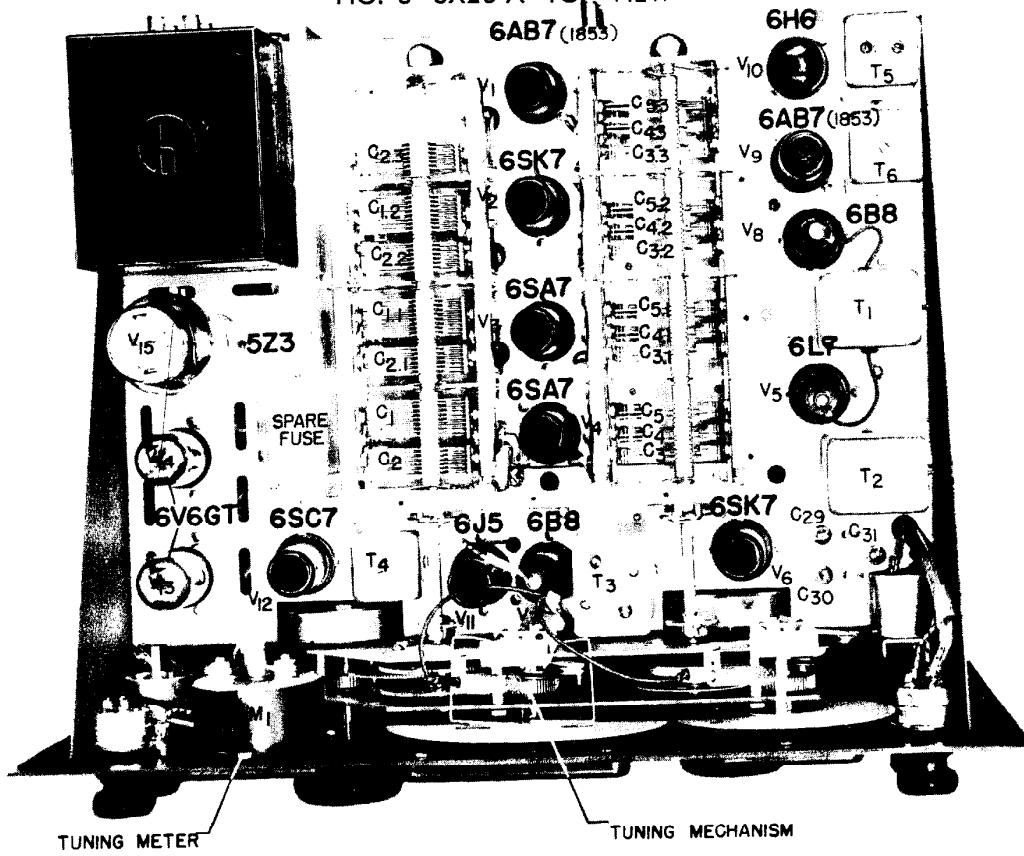

FIG. 9—SX28-A—REAR VIEW

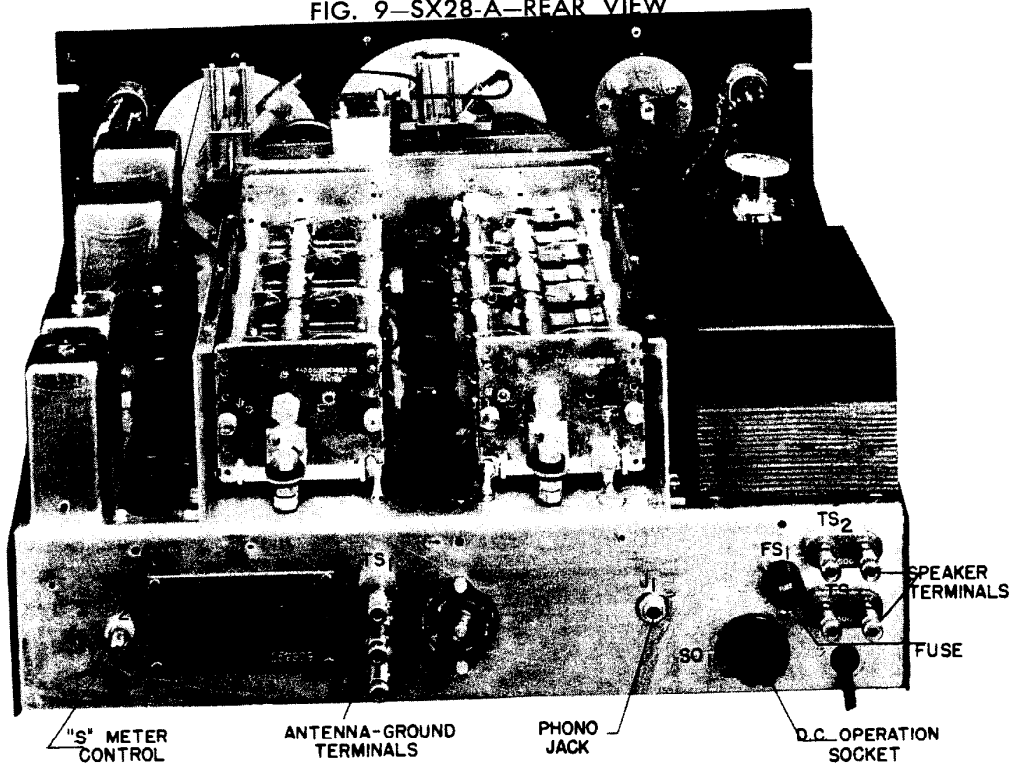

FIG. 10—AUDIO FIDELITY CURVE

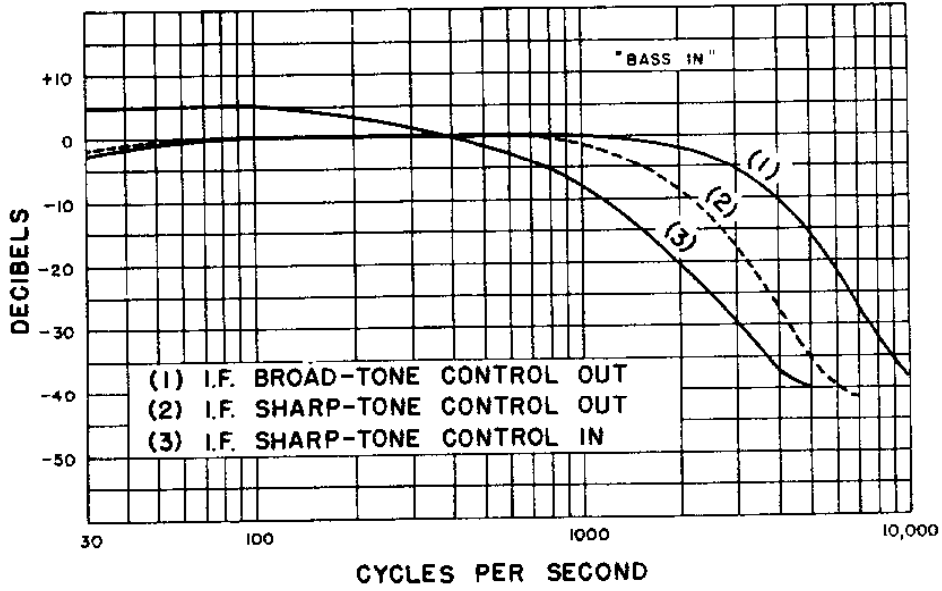

FIG. 11—AUDIO FILTER CURVE

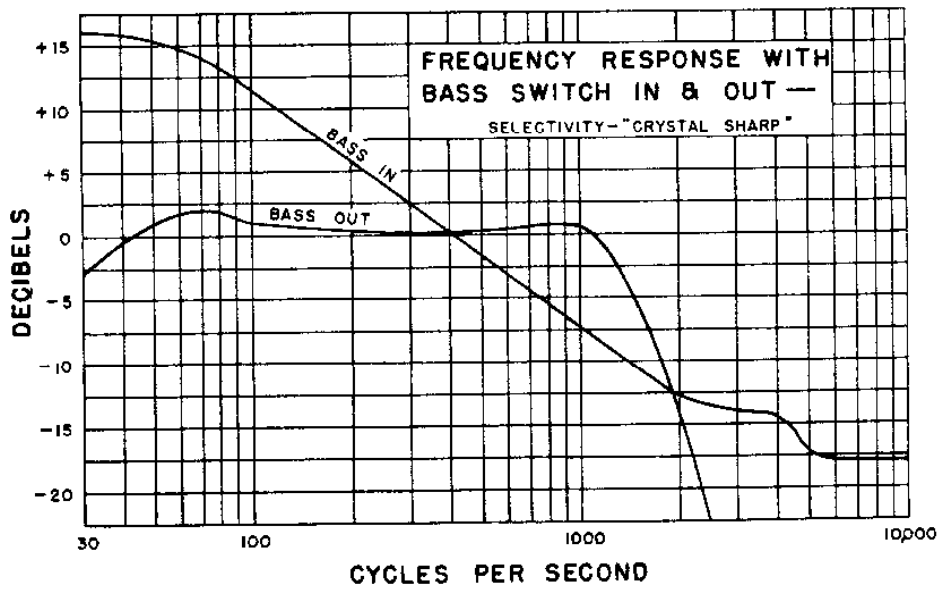
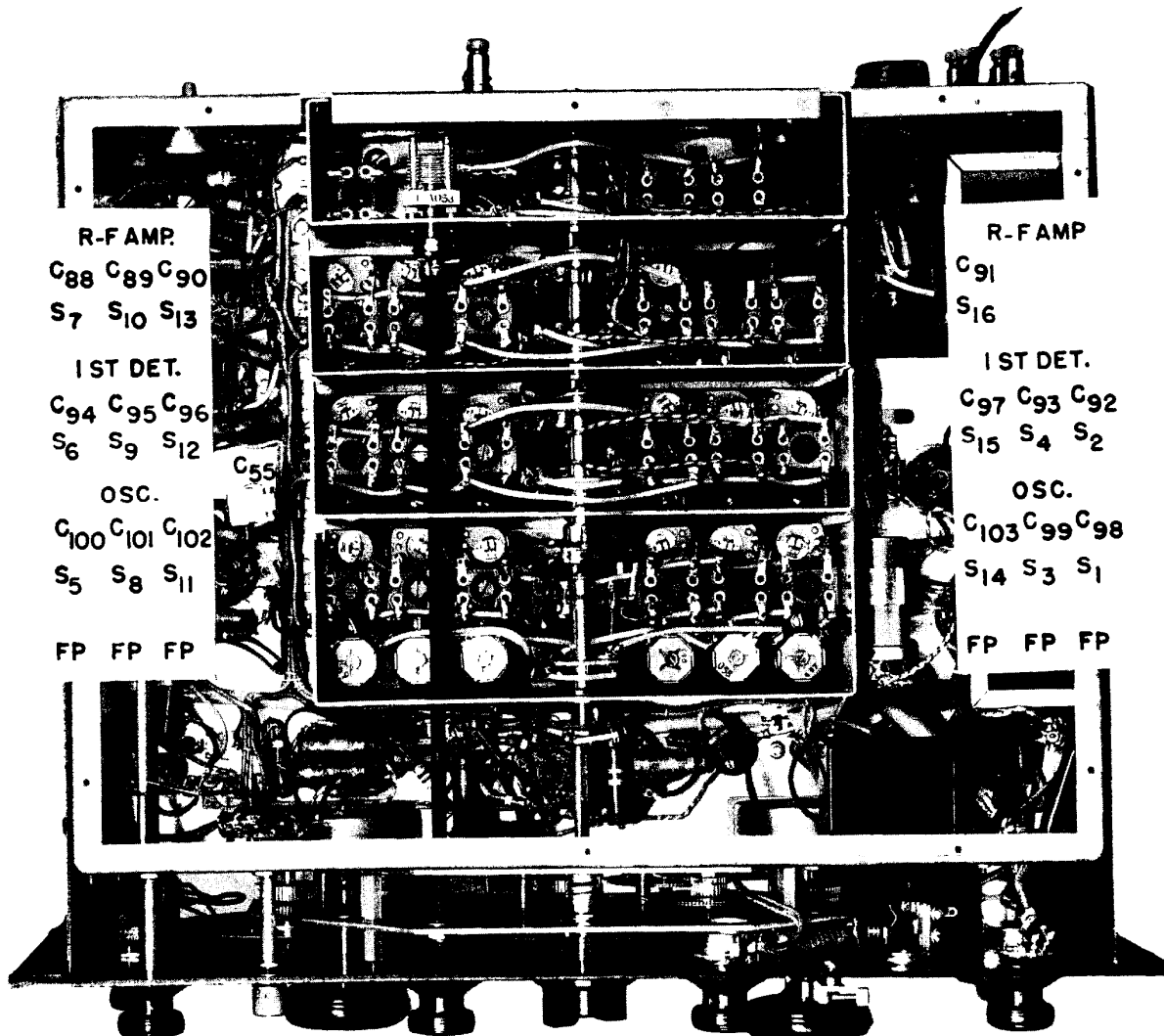

FIG. 12—RF AND OSC ADJUSTMENT LOCATION AND ALIGNMENT PROCEDURE



RF & OSC. ALIGNMENT PROCEDURE								
Connect hot lead of signal generator to A <sub>1</sub> —through dummy antenna shown in table. Leave jumper connected between A <sub>2</sub> and G. Ground of Generator to Chassis 'FP' indicates fixed pad—do not adjust.								
Band	Rec. Dial Setting	Sig. Gen. Freq.	Dummy Antenna	HIGH FREQUENCY END			LOW FREQUENCY END	
				Adjust Osc. With	Adjust Trimmers for Max. Gain		Adjust Osc. With	Permeability Tuned By
1	1.5 mc	1.5 mc	200 mmf	C <sub>98</sub>	C <sub>92</sub>		.....	.....
1	.6	.6	200 mmf	.....	.....		S <sub>1</sub>	S <sub>2</sub>
2	3.0	3.0	400 ohms	C <sub>99</sub>	C <sub>93</sub>		.....	.....
2	1.8	1.8	400 ohms	.....	.....		S <sub>3</sub>	S <sub>4</sub>
3	5.4	5.4	400 ohms	C <sub>100</sub>	C <sub>94</sub>	C <sub>88</sub>	.....	.....
3	3.0	3.0	400 ohms	.....	.....		S <sub>5</sub>	S <sub>6</sub> S <sub>7</sub>
4	10.0	10.0	400 ohms	C <sub>101</sub>	C <sub>95</sub>	C <sub>89</sub>	.....	.....
4	7.0	7.0	400 ohms	.....	.....		S <sub>8</sub>	S <sub>9</sub> S <sub>10</sub>
5	20.0	20.0	400 ohms	C <sub>102</sub>	C <sub>96</sub>	C <sub>90</sub>	.....	.....
5	12.0	12.0	400 ohms	.....	.....		S <sub>11</sub>	S <sub>12</sub> S <sub>13</sub>
6	36.0	36.0	400 ohms	C <sub>103</sub>	C <sub>97</sub>	C <sub>91</sub>	.....	.....
6	24.0	24.0	400 ohms	.....	.....		S <sub>14</sub>	S <sub>15</sub> S <sub>16</sub>

E

The following measurements made with a 20,000 ohms per volt meter and taken from the socket terminal indicated to ground or receiver chassis. Antenna and ground were disconnected from the receiver when these measurements were taken and the RF and AF gain controls set at maximum. "DL" means Dead Lug but will indicate voltage when used as a tie. Normal tolerance allows a variation of  $\pm 10\%$  from the indicated values.

TUBE	FUNCTION	SOCKET TERMINALS								
		1	2	3	4	5	6	7	8	Cap
V <sub>1</sub> -6AB7	RF Amp.				0 1	4 15	170	6 3	227	
V <sub>2</sub> -6SK7	RF Amp.			4 35	0 1	4 35	105	6 3	279	
V <sub>3</sub> -6SA7	Mixer			250	100	0 12	4 1	6 3		
V <sub>4</sub> -6SA7	HF Osc.			116	116	0 3	..	6 3	116	
V <sub>5</sub> -6L7	IF Amp Noise Limiter			245	102			6 3	4	-.075
V <sub>6</sub> -6SK7	IF Amp.			4		4	107 5	6 3	235	
V <sub>7</sub> -6B8	2nd Det S Meter Tube			17 2	- 255	- 255	108	6 3		- 17
V <sub>8</sub> -6B8	AVC Amp			225.5	0 2	0 2	107	6 3	2	
V <sub>9</sub> -6AB7	Noise Amp.				07	1 1	150	6 3	225	
V <sub>10</sub> -6H6	Noise Rectifier				1		17 6 DL	6 3	- 1	
V <sub>11</sub> -6J5	Beat Osc			140		-7.4		6 3		BFO ON ONLY FOR TEST
V <sub>12</sub> -6SC7	1st Audio Amp		140			137	1 4	6 3		
V <sub>13</sub> -6V6GT	P P Audio Amp.			310	290		198 DL	6 3	17	
V <sub>14</sub> -6V6GT	P P Audio Amp.			310	290			6 3	17	
V <sub>15</sub> -5Z3	Rectifier *	320	340 AC	340 AC	320					

\* 5 V AC between Terminals 1 & 4

## GUARANTEE

F

This receiver is guaranteed to be free from any defect in workmanship and material that may develop within a period of ninety (90) days from date of purchase, under the terms of the standard guarantee, as designated by the Radio Manufacturers Association. Any part or parts that prove defective within this period will be replaced without charge when subjected to examination at our factory, providing such defect, in our opinion, is due to faulty material or workmanship, and not caused by tampering, abuse or normal wear. All such adjustments to be made F.O.B. the factory.

Should this receiver require any adjustments, your dealer or distributor has complete technical service in

formation, or the factory will be glad to assist you in any problem direct.

Should it be necessary to return any part or parts to the factory, a Return Material Permit must be obtained in advance by first writing the Adjustment Department, who will issue due authorization under the terms of the guarantee.

The Hallicrafters Co. reserves the right to make changes in design or add improvements to instruments manufactured by them, without incurring any obligation to install the same in any instrument previously purchased.

All Hallicrafters receivers are built under patents of Radio Corporation of America and Hazeltine Corporation.



6. LIST OF REPLACEABLE PARTS MODEL SX-28-A

REF. SYMBOL	NAME OF PART AND DESCRIPTION	FUNCTION	MFR. CODE	CONTR.'S. PART NO.
R <sub>1</sub>	Resistor, 100,000 ohm ± 10%, ½ watt, carbon	A-V-C decoupling for tube V <sub>1</sub>	ASA	RC21AE104K
R <sub>2</sub>	Resistor, variable, 10,000 ohm ± 20% carbon, type 35	R.F. Gain control	CT	25C066
R <sub>3</sub>	Resistor, 330 ohm ± 10%, ½ watt, carbon	Cathode bias for tube V <sub>1</sub>	ASA	RC21AE331K
R <sub>4</sub>	Resistor, 27,000 ohm ± 10%, 1 watt, carbon	Voltage drop for screen of tube V <sub>1</sub>	ASA	RC31AE273K
R <sub>5</sub>	Resistor, 1000 ohm ± 10%, ½ watt, carbon	Plate decoupling for tube V <sub>1</sub>	ASA	RC21AE102K
R <sub>6</sub>	Resistor, 6,800 ohm ± 10%, 2 watt, carbon	Plate decoupling for tube V <sub>4</sub>	ASA	RC41AE682K
R <sub>7</sub>	Same as R <sub>1</sub>	A-V-C decoupling for tube V <sub>2</sub>		
R <sub>8</sub>	Same as R <sub>3</sub>	Cathode bias for tube V <sub>2</sub>		
R <sub>9</sub>	Same as R <sub>5</sub>	Voltage drop for screen of tube V <sub>2</sub>		
R <sub>10</sub>	Resistor, 2700 ohm, ± 10%, ½ watt, carbon	Plate decoupling for tube V <sub>2</sub>	ASA	RC21AE272K
R <sub>11</sub>	Same as R <sub>1</sub>	A-V-C decoupling for tube V <sub>3</sub>		
R <sub>12</sub>	Resistor, 390 ohm ± 10%, ½ watt, carbon	Cathode bias for tube V <sub>3</sub>	ASA	RC21AE391K
R <sub>13</sub>	Same as R <sub>5</sub>	Voltage drop for screen of tube V <sub>3</sub>		
R <sub>14</sub>	Same as R <sub>10</sub>	Plate decoupling for tube V <sub>3</sub>		
R <sub>15</sub>	Same as R <sub>1</sub>	A-V-C decoupling for tube V <sub>5</sub>		
R <sub>16</sub>	Resistor, 270 ohm ± 10%, ½ watt, carbon	Cathode bias for tube V <sub>5</sub> on bands 1, 2 and 6	ASA	RC21AE271K
R <sub>17</sub>	Same as R <sub>5</sub>	Voltage drop for screen of tube V <sub>5</sub>		
R <sub>18</sub>	Same as R <sub>10</sub>	Plate decoupling for tube V <sub>5</sub>		
R <sub>19</sub>	Same as R <sub>1</sub>	Grid return for tube V <sub>6</sub>		
R <sub>20</sub>	Resistor, 470,000 ohm ± 10%, ½ watt, carbon	Grid return for tube V <sub>6</sub>	ASA	RC21AE474K
R <sub>21</sub>	Resistor, 270 ohm ± 10%, ½ watt, carbon	Cathode bias for tube V <sub>6</sub>	ASA	RC21AE271K
R <sub>22</sub>	Same as R <sub>5</sub>	Voltage drop for screen of tube V <sub>6</sub>		
R <sub>23</sub>	Same as R <sub>10</sub>	Plate decoupling for tube V <sub>6</sub>		
R <sub>24</sub>	Same as R <sub>1</sub>	Diode load for tube V <sub>7</sub>		
R <sub>25</sub>	Same as R <sub>20</sub>	Diode load for tube V <sub>7</sub>		
R <sub>26</sub>	Resistor, 1,000 ohm ± 10%, ½ watt, carbon	Cathode bias for tube V <sub>5</sub> for bands 3 and 5	ASA	RC21AE102K
R <sub>27</sub>	Same as R <sub>20</sub>	A-V-C decoupling for tube V <sub>5</sub> and grid isolation for tube V <sub>7</sub>		
R <sub>28</sub>	Resistor, 100 ohm ± 10%, ½ watt, carbon	Carrier level meter shunt	ASA	RC21AE101K
R <sub>29</sub>	Resistor, variable, 500 ohm ± 20%, carbon, type 25	Carrier level meter, zero adjustment	CT	25C022
R <sub>30</sub>	Resistor, 27,000 ohm ± 10%, 2 watt, carbon	Voltage drop for plate of tube V <sub>7</sub>	ASA	RC41AE273K
R <sub>31</sub>	Resistor, two sections; section #1 (R <sub>31</sub> ), 11,000 ohm ± 10%, 1½ watts; section #2 (R <sub>32</sub> ) 4,000 ohm ± 10%, 7 watts; metal clad, wire wound	Voltage divider for screen grids of tubes V <sub>2</sub> , V <sub>3</sub> , V <sub>5</sub> , V <sub>6</sub> , V <sub>7</sub> and V <sub>8</sub>	CS	24A046
R <sub>32</sub>				

6. LIST OF REPLACEABLE PARTS - (Cont'd.)

REF. SYMBOL	NAME OF PART AND DESCRIPTION	FUNCTION	MFR. CODE	CONTR.'S. PART NO.
R <sub>33</sub>	Resistor, variable, 500,000 ohm ± 50%, carbon	A.F. gain control	CT	25C065
R <sub>34</sub>	Same as R <sub>33</sub>	Cathode bias for tube V <sub>12</sub>		
R <sub>35</sub>	Resistor, variable, 500,000 ohm ± 20%, carbon type AE-35-500M ∞	TPNE control	CT	25C064
R <sub>36</sub>	Same as R <sub>31</sub>	Plate load for tube V <sub>12</sub>		
R <sub>37</sub>	Same as R <sub>31</sub>	Plate load for tube V <sub>12</sub>		
R <sub>38</sub>	Resistor, 4", 000 ohm ± 10%, ½ watt, carbon	Plate decoupling for tube V <sub>12</sub>	ASA	RC21AE473K
R <sub>39</sub>	Resistor, 180,000 ohm ± 10%, ½ watt, carbon	Grid return for tubes V <sub>12</sub> , V <sub>13</sub> and V <sub>14</sub>	ASA	RC21AE184K
R <sub>40</sub>	Resistor, 270,000 ohm ± 10%, ½ watt, carbon	Grid return for tube V <sub>13</sub>	ASA	RC21AE274K
R <sub>41</sub>	Same as R <sub>40</sub>	Grid return for tube V <sub>14</sub>		
R <sub>42</sub>	Resistor, 220 ohm ± 10%, 2 watt, wire wound, type BW2	Cathode bias for tubes V <sub>13</sub> and V <sub>14</sub>	IRC	24BV221E
R <sub>43</sub>	Resistor, 20,000 ohm ± 5%, 2 watt, carbon	Load for primary winding of transformer T <sub>8</sub>	ASA	RC41AE203J
R <sub>44</sub>	Resistor, 5,000 ohm ± 20%, 10 watt, wire wound, vitereous enamel, type CC	Load for secondary of transformer T <sub>8</sub> during headset operation.	U	24BG502F
R <sub>45</sub>	Same as R <sub>43</sub>	Plate load for tube V <sub>11</sub>		
R <sub>46</sub>	Same as R <sub>38</sub>	Grid return for tube V <sub>11</sub>		
R <sub>47</sub>	Resistor, 10 ohm ± 10%, ½ watt, carbon	Parasitic suppressor for tube V <sub>4</sub>	ASA	RC21AE100K
R <sub>48</sub>	Same as R <sub>31</sub>	Cathode bias for tube V <sub>10</sub>		
R <sub>49</sub>	Resistor, 1 megohm ± 10%, ½ watt carbon,	Diode load for A-N-L tube V <sub>10</sub>	ASA	RC21AE105K
F <sub>50</sub>	Resistor, 560 ohm ± 10%, ½ watt, carbon	Plate decoupling for tube V <sub>9</sub>	ASA	RC21AE561K
F <sub>51</sub>	Resistor, 20,000 ohm ± 5%, 1 watt, carbon	Screen decoupling for tube V <sub>9</sub>	ASA	RC31AE203J
R <sub>52</sub>	Same as R <sub>38</sub>	A-N-L bias voltage divider	CT	25C067
F <sub>53</sub>	Resistor, variable, 50,000 ohm ± 20%, carbon with DPST switch, type WR-35	A-N-L Control		
R <sub>54</sub>	Resistor, 33 ohm ± 10%, ½ watt, carbon	Cathode bias for tube V <sub>9</sub>	ASA	RC21AE330K
R <sub>55</sub>	Same as R <sub>20</sub>	Grid return for tube V <sub>9</sub>		
R <sub>56</sub>	Same as R <sub>5</sub>	Voltage drop for screen of tube V <sub>8</sub>		
R <sub>57</sub>	Same as R <sub>1</sub>	A-V-C decoupling for tube V <sub>9</sub>		
R <sub>58</sub>	Resistor, 180 ohm ± 10%, ½ watt, carbon	Cathode bias for tube V <sub>8</sub>	ASA	RC21AE181K
R <sub>59</sub>	Same as R <sub>1</sub>	Diode load for tube V <sub>8</sub>		
R <sub>60</sub>	Same as R <sub>40</sub>	Diode load for tube V <sub>8</sub>		
R <sub>61</sub>	Same as R <sub>20</sub>	A-V-C decoupling for r-f stages		
R <sub>62</sub>	Same as R <sub>20</sub> . Part of transformer T <sub>1</sub> . Shown for reference only.	Grid return for tube V <sub>8</sub>		
R <sub>63</sub>	Same as R <sub>14</sub>	Plate decoupling for tube V <sub>8</sub>		

6. LIST OF REPLACEABLE PARTS - (Cont'd.)

REF. SYMBOL	NAME OF PART AND DESCRIPTION	FUNCTION	MFR. CODE	CONTR.'S. PART NO.
R64	Same as R20	A-V-C decoupling for r-f stages		
R65	Same as R38	Injector grid return for tube V3		
R66	Same as R38	Grid return for tube V4		
R67	Same as R50	Plate load for tube V1 on Band 1		
R68	Resistor, 1,200 ohm ± 10%, ½ watt, carbon	Cathode bias for tube V5 on Band 4	ASA	RC21AE122K
R69	Same as R1	Primary load for transformer T5		
R70	Same as R49	A-N-L circuit balance		
R71	Resistor, 4700 ohm ± 10%, 1 watt, carbon	Plate decoupling for tube V4	ASA	RC31AE472K
R72	Same as R50	Plate load for tube V1 on Band 1		
R73	Not used			
R74	Same as R47	Parasitic suppressor for tube V1		
C1	Capacitor, variable, 4 unit gang, each unit consists of 2 sections, except unit 4 at rear which contains only one section (section #2), air dielectric, special; Section #1-min. cap. 16.3 mmfd., max. cap. 187.5 mmfd. (C1, C1.1, C1.2); Section #2-min. cap. 21.5 mmfd., max. cap. 250.0 mmfd. (C2, C2.1, C2.2, C2.3).	Oscillator stage tuning for Band 1 only Converter stage tuning for Band 1 only Antenna stage tuning for Band 1 only Oscillator stage tuning for Bands 3, 4, 5 and 6 Converter stage tuning for Bands 3, 4, 5 and 6 R-F amplifier stage tuning for Bands 3, 4, 5 and 6 Antenna stage tuning for Bands 3, 4, 5 and 6	RC	48B050
C1.1				
C1.2				
C2				
C2.1				
C2.2				
C2.3				
C3	Capacitor, variable, 4 unit gang, each unit consists of 3 sections, air dielectric, special; Section #1-min. cap. 6 mmfd., max. cap. 16 mmfd. (C3, C3.1, C3.2, C3.3); Section #2-min. cap. 6.5 mmfd., max. cap. 21.5 mmfd. (C4, C4.1, C4.2, C4.3); Section #3-min. cap. 6.5 mmfd., max. cap. 27 mmfd. (C5, C5.1, C5.2, C5.3).	Oscillator stage bandspread tuning for 80 and 20 meter bands Converter stage bandspread tuning for 80 and 20 meter bands R-F amplifier stage bandspread tuning for 80 and 20 meter bands Antenna stage bandspread tuning for 80 and 20 meter bands Oscillator stage bandspread tuning for 80 and 40 meter bands Converter stage bandspread tuning for 80 and 40 meter bands	RC	48B051
C3.1				
C3.2				
C3.3				
C4				
C4.1				

6. LIST OF REPLACEABLE PARTS - (Cont'd.)

REF. SYMBOL	NAME OF PART AND DESCRIPTION	FUNCTION	MFR. CODE	CONTR.'S. PART NO.
C4.2	Capacitor, variable, 4 unit gang, each unit consists of 3 sections, air dielectric, special; Section #1-min. cap. 6 mmfd., max. cap. 16 mmfd. (C3, C5.1, C3.2, C3.3); Section #2-min. cap. 6.5 mmfd., max. cap. 21.5 mmfd. (C4, C4.1, C4.2, C4.3); Section #3-min. cap. 6.5 mmfd., max. cap. 27 mmfd. (C5, C5.1, C5.2, C5.3)	R-F amplifier stage bandsread tuning for 80 and 40 meter bands Antenna stage bandsread tuning for 80 and 40 meter bands Oscillator stage bandsread tuning for 80 and 20 meter bands Converter stage bandsread tuning for 80 and 30 meter bands	RC	48B051
C4.3				
C5				
C5.1				
C5.2				
C5.3				
C6	Capacitor, variable, min. cap. 3.5 mmfd., max. cap. 50 mmfd., air dielectric, ceramic insulation, type 22	ANT. TRIMMER control	RC	48A053
C7	Capacitor, 2980 mmfd. adjustable $\pm 5\%$ , mica dielectric, steel mtg. frame, special	Oscillator padding for Band 6	UE	44B110
C8	Capacitor, 2400 mmfd. adjustable $\pm 5\%$ , mica dielectric, steel mtg. frame, special	Oscillator padding for Band 5	UE	44B109
C9	Capacitor, 2240 mmfd. adjustable $\pm 5\%$ , mica dielectric, steel mtg. frame, special	Oscillator padding for Band 4	UE	44B108
C10	Capacitor, 1700 mmfd. adjustable $\pm 5\%$ , mica dielectric, steel mtg. frame, special	Oscillator padding for Band 3	UE	44B107
C11	Capacitor, 822 mmfd. adjustable $\pm 5\%$ , mica dielectric, steel mtg. frame, special	Oscillator padding for Band 2	UE	44B106
C12	Capacitor, 541 mmfd. adjustable $\pm 5\%$ , mica dielectric, steel mtg. frame, special	Oscillator padding for Band 1	UE	44B105
C13	Capacitor, adjustable, 5 mmfd. $\pm 0.2$ mmfd. at 25° C., capacity change -0.02 mmfd. per ° C., type S-2739	Temperature compensating capacity for oscillator	UE	44A062
C14	Capacitor, 0.02 mfd. -10 + 40%, 400 V.D-C working, paper dielectric	Cathode by-pass for tube V1	SP	46AW203J
C15	Same as C14	Screen by-pass for tube V1	SP	46AY203J
C16				
C17	Capacitor, fixed, 0.02 mfd. - 10 + 40%, 600 V. D-C working, paper dielectric	Plate return by-pass for tube V1	SP	46AU503J
C18	Capacitor, fixed, 0.05 mfd. - 10 + 40%, 200 V. D-C working, paper dielectric	A-V-C by-pass for tube V1	SP	46AU503J
C19	Same as C14	Cathode by-pass for tube V2		
C20	Same as C14	Screen by-pass for tube V2		
C21	Same as C15	Plate return by-pass for tube V2		
C22	Same as C17	A-V-C by-pass for tube V3		

6. LIST OF REPLACEABLE PARTS - (Cont'd.)

REF. SYMBOL	NAME OF PART AND DESCRIPTION	FUNCTION	MFR. CODE	CONTR.'S. PART NO.
C22	Same as C14	Cathode by-pass for tube V3		
C23	Same as C14	Screen by-pass for tube V3		
C24	Same as C16	Plate return by-pass for tube V3		
C25	Capacitor, fixed, 2200 mmfd. ± 10%, 500 V. D-C working, mica dielectric	A-V-C by-pass for tube V5	ASA	CM30A222K
C26	Same as C17	Cathode by-pass for tube V5		
C27	Same as C14	Screen by-pass for tube V5		
C28	Same as C16	Plate return by-pass for tube V5		
C29	Capacitor, variable, min. cap. 2 mmfd., max. cap. 6 mmfd., ceramic dielectric, special mtg. bracket, type B-820-202	MED. XTAL crystal filter adjustment	CRL	44A079
C30	Capacitor, variable, min. cap. 4 mmfd., max. cap. 20 mmfd., ceramic dielectric, special mtg. bracket, type B-820-304	SHARP XTAL crystal filter adjustment	CRL	44A078
C31	Same as C30	SHARP I.F. crystal filter adjustment	RC	48A039
C32	Capacitor, variable, min. cap. 3.0 mmfd., max. cap. 25 mmfd., air dielectric, ceramic insulation, type 22-7	CRYSTAL PHASING control		
C33	Same as C14	Grid return by-pass for tube V6		
C34	Same as C17	Cathode by-pass for tube V6		
C35	Same as C14	Screen by-pass for tube V6		
C36	Same as C16	Plate return by-pass for tube V6		
C37	Capacitor, fixed, 47 mmfd. ± 10%, 500 V. D-C working, mica dielectric	Diode load by-pass for tube V7	ASA	CM20A470K
C38	Not used			
C39	Same as C14	R-F by-pass on grid of tube V7		
C40	Capacitor, fixed, 470 mmfd. ± 10%, 500 V. D-C working, mica dielectric	Parasitic suppressor in plate of tube V12	ASA	CM20A471K
C41	Capacitor, fixed, one unit of dual unit, 40 mfd. - 10 - 40%, 25 V. D-C working, electrolytic (See C44)	Cathode by-pass for tube V12	SP	42A032
C42	Same as C16	Tone control, high frequency audio shunt		
C43	Capacitor, fixed, 5100 mmfd. ± 5%, 300 V. D-C working, mica dielectric	Resonating capacitor for bass boost	ASA	CM35A512J
C44	Capacitor, fixed, one unit of dual unit, 10 mfd. - 10 - 10%, 300 V. D-C working, electrolytic (See C41)	Plate decoupling for tube V12		

6. LIST OF REPLACEABLE PARTS - (Cont'd.)

REF. SYMBOL	NAME OF PART AND DESCRIPTION	FUNCTION	MFR. CODE	CONTR.'S. PART NO.
C45	Capacitor, fixed, 0.05 mfd. - 10 + 40%, 400 V. D-C working, paper dielectric	Coupling between tubes V <sub>12</sub> and V <sub>14</sub>	SP	46AW503J
C46	Same as C <sub>45</sub>	Coupling between tubes V <sub>12</sub> and V <sub>13</sub>		
C47	Capacitor, fixed, one unit of dual unit, 40 mfd. - 10 + 40%, 25 V. D-C working, electrolytic (See C <sub>48</sub> )	Cathode by-pass for tubes V <sub>13</sub> and V <sub>14</sub>	SP	42A031
C48	Capacitor, fixed, one unit of dual unit, 30 mfd. - 10 + 40%, 400 V. D-C working, electrolytic in same container with C <sub>47</sub>	Plate power supply output filter capacitor		
C49	Capacitor, fixed, 30 mfd. - 10 + 40%, 450 V. D-C working, electrolytic, type D8290	Plate power supply input filter capacitor	SP	42A030
C50	Same as C <sub>14</sub>	Audio coupling between diode of tube V <sub>7</sub> and grid of tube V <sub>12</sub>		
C51	Capacitor, fixed, 0.01 mfd. - 10 + 40%, 600 V. D-C working, paper dielectric	A-C line by-pass capacitor	SP	46AY103J
C52	Same as C <sub>51</sub>	A-C line by-pass capacitor		
C53	Same as C <sub>17</sub>	A-N-L by-pass		
C54	Same as C <sub>45</sub>	Cathode by-pass for tube V <sub>10</sub>		
C55	Capacitor, variable, compression type, 50 mmfd. (nominal), mica dielectric, type SW-1530	Resonating trimmer for inductor CH <sub>3</sub>	SWI	53A012
C56	Same as C <sub>16</sub>	Plate return by-pass for tube V <sub>9</sub>		
C57	Same as C <sub>14</sub>	Screen by-pass for tube V <sub>9</sub>		
C58	Same as C <sub>17</sub>	Cathode by-pass for tube V <sub>9</sub>		
C59	Same as C <sub>17</sub>	A-V-C by-pass for tube V <sub>9</sub>		
C60	Same as C <sub>37</sub>	Coupling between tube V <sub>3</sub> and tube V <sub>9</sub>		
C61	Capacitor, fixed, 250 mmfd. ± 20%, 500 V. D-C working, mica dielectric, type 1468. Part of transformer T <sub>1</sub> . Shown for reference only.	Coupling between tube V <sub>3</sub> and tube V <sub>8</sub>		
C62	Same as C <sub>14</sub>	Screen by-pass for tube V <sub>8</sub>		
C63	Same as C <sub>17</sub>	Cathode by-pass for tube V <sub>8</sub>		
C64	Capacitor, fixed, 100 mmfd. ± 10%, 500 V. D-C working, mica dielectric	A-V-C diode load by-pass at tube V <sub>8</sub>	ASA	CM20A10IK
C65	Same as C <sub>14</sub>	A-V-C by-pass for Bands 2,3,4,5 and 6		
C66	Same as C <sub>17</sub>	A-V-C by-pass for Band 1		
C67	Same as C <sub>16</sub>	Plate return by-pass for tube V <sub>8</sub>		
C68	Same as C <sub>37</sub>	Coupling between oscillator tube V <sub>4</sub> and converter tube V <sub>3</sub>		

6. LIST OF REPLACEABLE PARTS - (Cont'd.)

REF. SYMBOL	NAME OF PART AND DESCRIPTION	FUNCTION	MFR. CODE	CONTR.'S. PART NO.
C69	Same as C57	Grid coupling for tube V4		
C70	Same as C25	Plate return by-pass for tube V4		
C71	Same as C64	Grid coupling for tube V11	RC	46A064
C72	Capacitor, variable, min. cap. 5 mmfd., max. cap. 25 mmfd., air dielectric, special	B.F.O. control		
C73	Capacitor, fixed, 500 mmfd. ± 5%, 500 V. D-C working, silver mica, type 1469, Part of transformer T4. Shown for reference only	Shunt capacitor across C72	A	47HT501D
C74	Capacitor, fixed, 0.01 mfd. -10 + 40%, 600 V. D-C working, paper dielectric, braided leads, type AB	Plate by-pass for tube V11	SP	46A021
C75	Capacitor, 2 mmfd., twisted leads	Coupling between tubes V7 and V11		
C76	Same as C25	Impedance equalizer for transformer T8		
C77	Same as C17	A-V-C by-pass for tube V1		
C78	Not used			
C79	Not used			
C80	Not used			
C81	Not used			
C82	Not used			
C83	Capacitor, fixed, 2.5 mmfd. ± 20%, 500 V. D-C working, bakelite dielectric	Coupling between tubes V2 and V3 on Band 5		49A001
C84	Not used			
C85	Not used			
C86	Same as C40	Plate decoupling for tube V4	SP	46AT254J
C87	Capacitor, fixed, 0.25 mfd. - 10 + 40%, 200 V. D-C working, paper dielectric	Cathode return by-pass		
C88	Capacitor, variable, min. cap. 4 mmfd., max. cap. 20 mmfd., ceramic insulation, temp. coeff. - 0.005 mmfd/mmfd/° C., type 820-B	Trimmer for transformer T15	CEL	44A102
C89	Same as C88	Trimmer for transformer T16		
C90	Same as C88	Trimmer for transformer T17		
C91	Same as C88	Trimmer for transformer T18		
C92	Capacitor, variable, min. cap. 2.5 mmfd., max. cap. 6 mmfd., ceramic insulation, temp. coeff. 0.0005 mmfd/mmfd/° C, special	Trimmer for transformer T19	CEL	44A119
C93	Same as C88	Trimmer for transformer T20		
C94	Same as C88	Trimmer for transformer T21		
C95	Same as C88	Trimmer for transformer T22		
C96	Same as C88	Trimmer for transformer T23		

G. LIST OF REPLACEABLE PARTS - (Cont'd.)

REF. SYMBOL	NAME OF PART AND DESCRIPTION	FUNCTION	MFR. CODE	CONTR.'S. PART NO.
C97	Same as C86	Trimmer for transformer T24		
C98	Same as C88	Trimmer for transformer T25		
C99	Same as C98	Trimmer for transformer T26		
C100	Same as C88	Trimmer for transformer T27		
C101	Same as C88	Trimmer for transformer T28		
C102	Same as C92	Trimmer for transformer T29		
C103	Same as C88	Trimmer for transformer T30		
C104	Capacitor, fixed, 275 mmfd., silver mica. Part of transformer T <sub>1</sub> . Shown for reference only.	{ Primary capacitor of transformer T <sub>1</sub> Secondary capacitor of transformer T <sub>1</sub>		
C105	Capacitor, fixed, 125 mmfd., silver mica. Part of transformer T <sub>2</sub> . Shown for reference only.		Primary capacitor of transformer T <sub>2</sub>	
C106	Capacitor, fixed, 85 mmfd., silver mica. Part of transformer T <sub>2</sub> . Shown for reference only.	Secondary capacitor of transformer T <sub>2</sub>		
C107	Capacitor assembly; fixed capacitor, 25 mmfd. ± 5%, silver mica; variable capacitor, min. cap. 70 mmfd., max. cap. 90 mmfd., ceramic dielectric; both capacitors connected in parallel to form assembly. Part of transformer T <sub>3</sub> . Shown for reference only.	{ Primary trimmer of transformer T <sub>3</sub> Secondary trimmer of transformer T <sub>3</sub>		
C108				
C109				
C110	Capacitor, variable, compression type, 80 mmfd., (nominal), mica dielectric. Part of transformer T <sub>5</sub> . Shown for reference only.	{ Primary trimmer of transformer T <sub>5</sub> Secondary trimmer for transformer T <sub>5</sub>		
C111				
C112	Capacitor, fixed, 100 mmfd. ± 10%, 500 V. D-C working, mica. Part of transformer T <sub>6</sub> . Shown for reference only.	Primary capacitor of transformer T <sub>6</sub>		
C113	Capacitor, fixed, 25 mmfd. ± 10%, 500 V. D-C working, mica. Part of transformer T <sub>6</sub> . Shown for reference only.	Secondary capacitor of transformer T <sub>6</sub>		
C114	Capacitor, fixed, 10 mmfd. ± 10%, 500 V. D-C working, ceramic dielectric, -0.00075 mmfd./mmfd./deg. Cent. temp. coeff., type class B modified	Additional coupling for transformer T <sub>20</sub>	CHL	47AD41
T1	Transformer, I-F, 455KC, primary and secondary tuned by adjustable iron core, secondary has expander winding, special.	Coupling between converter V <sub>3</sub> and 1st i-f amplifier V <sub>5</sub>	SI	50E082



6. LIST OF REPLACEABLE PARTS - (Cont'd.)

QTY.	NAME OF PART AND DESCRIPTION	FUNCTION	MFR. CODE	CONTR.'S. PART NO.
T <sub>2</sub>	Transformer, I-F, 455KC, primary and secondary tuned by adjustable iron core, secondary tapped for crystal filter and variable band width, primary has expansion winding- special	Coupling and filter between i-f amplifier tubes V <sub>5</sub> and V <sub>6</sub>	SI	5CB081
T <sub>3</sub>	Transformer, I-F, 455-K, primary and secondary tuned by variable capacitor, iron core coils, type 5265	Coupling between i-f amplifier tube V <sub>6</sub> and diode of 2nd detector tube V <sub>7</sub>	SWI	5OF083
T <sub>4</sub>	Transformer, 455KC, tuned by adjustable iron core, special	Beat frequency oscillator inductance	SWI	54B014
T <sub>5</sub>	Transformer, I-F, 455KC, primary and secondary tuned by variable capacitor, iron core coils special	Coupling between A-N-L tubes V <sub>9</sub> and V <sub>10</sub>	SWI	5OB097
T <sub>6</sub>	Transformer, I-F, 455KC, primary tuned by adjustable iron core, secondary adjustable iron core, special	Coupling for A-V-C amplifier tube V <sub>8</sub>	SWI	5OB080
T <sub>7</sub>	Transformer, power, standard; primary, 117 V. A-C, single phase, 50/60 cycle; secondary, 580 V. A-C @ 185 ma., center tapped; 0.7 V. A-C @ 5.5 amperes, 5 V. A-C @ 3 amperes, type 6746	Filament and plate power transformer	GT	52E033
T <sub>8</sub>	Transformer, power, universal; primary, 117/230 V. A-C, single phase, 50 60 cycles; secondary-some as standard transformer, type 9361	Couples a-f amplifier to load.	GT	52B034
T <sub>9</sub>	Transformer, A-F; primary, 10,000 ohm winding center tapped; secondary, 5000 ohm winding tapped at 500 and 100 ohms, iron core, type 27347		GT	55B009
T <sub>10</sub>	Transformer, R-R, range 3.0-5.8 megacycles, air core, special	Coupling between antenna and tube V <sub>1</sub> for Band 3	SWI	51B568
T <sub>11</sub>	Transformer, R-F, range 6.8-11.5 megacycles, air core, special	Coupling between antenna and tube V <sub>1</sub> for Band 4	SWI	51P569
T <sub>12</sub>	Transformer, V-F, range 10.5-21 megacycles, air core, special	Coupling between antenna and tube V <sub>1</sub> for Band 5	SWI	51F570
T <sub>13</sub>	Transformer, U-F, range 11-13 megacycles, air core, special	Coupling between antenna and tube V <sub>1</sub> for Band 6	SWI	51P571
T <sub>14</sub>	Transformer, V, U, range .55-1.8 megacycles, air core, special	Coupling between antenna and tube V <sub>2</sub> for Band 1	SWI	51P583

6. LIST OF REPLACEABLE PARTS - (Cont'd.)

REP. SYMBOL	NAME OF PART AND DESCRIPTION	FUNCTION	MFR. CODE	CONTR.'S. PART NO.
T14	Transformer, R-F, range, 1.6-3.0 megacycles, air core, special	Coupling between antenna and tube V <sub>2</sub> for Band 2	SWI	51B567
T15	Transformer, R-F, range, 3.0-5.8 megacycles, adjustable iron core, special	Coupling between tube V <sub>1</sub> and tube V <sub>2</sub> for Band 3	SWI	51B572
T16	Transformer, R-F, range 5.8-11.5 megacycles, adjustable iron core, special	Coupling between tube V <sub>1</sub> and tube V <sub>2</sub> for Band 4	SWI	51B573
T17	Transformer, R-F, range 10.5-21 megacycles, adjustable iron core, special	Coupling between tube V <sub>1</sub> and tube V <sub>2</sub> for Band 5	SWI	51B574
T18	Transformer, R-F, range 21-42 megacycles, adjustable iron core, special	Coupling between tube V <sub>1</sub> and tube V <sub>2</sub> for Band 6	SWI	51B575
T19	Transformer, R-F, range .55-1.6 megacycles, adjustable iron core, special	Coupling between tube V <sub>2</sub> and tube V <sub>3</sub> for Band 1	SWI	51B576
T20	Transformer, R-F, range 1.6-3.0 megacycles, adjustable iron core, special	Coupling between tube V <sub>2</sub> and tube V <sub>3</sub> for Band 2	SWI	51B577
T21	Transformer, R-F, range 3.0-5.8 megacycles, adjustable iron core, special	Coupling between tube V <sub>2</sub> and tube V <sub>3</sub> for Band 3	SWI	51B578
T22	Transformer, R-F, range 5.8-11.5 megacycles adjustable iron core, special	Coupling between tube V <sub>2</sub> and tube V <sub>3</sub> for Band 4	SWI	51B579
T23	Transformer, R-F, range 10.5-21 megacycles, adjustable iron core, special	Coupling between tube V <sub>2</sub> and tube V <sub>3</sub> for Band 5	SWI	51B580
T24	Transformer, R-F, range 21-42 megacycles, adjustable iron core, special	Coupling between tube V <sub>2</sub> and tube V <sub>3</sub> for Band 6	SWI	51B581
T25	Transformer, R-F, range .55-1.6 megacycles, adjustable iron core, special	Oscillator coil for Band 1	SWI	51B582
T26	Transformer, R-F, range 1.6-3.0 megacycles, adjustable iron core, special	Oscillator coil for Band 2	SWI	51B583
T27	Transformer, R-F, range 3-5.8 megacycles, adjustable iron core, special	Oscillator coil for Band 3	SWI	51B584
T28	Transformer, R-F, range 5.8-11.5 megacycles, adjustable iron core, special	Oscillator coil for Band 4	SWI	51B585
T29	Transformer, R-F, range 10.5-21 megacycles, adjustable iron core, special	Oscillator coil for Band 5	SWI	51B586
T30	Transformer, R-F, range 21-42 megacycles, adjustable iron core, special	Oscillator coil for Band 6	SWI	51B587

6. LIST OF REPLACEABLE PARTS - (Cont'd.)

REF. SYMBOL	NAME OF PART AND DESCRIPTION	FUNCTION	MFG. CODE	CONTR.'S. PART NO.
CH <sub>1</sub>	Inductor, 13 henries ± 10%, @ 100 milliamperes D-C, d-c resistance 300 ohms ± 10%, iron core, type 1D25	Plate supply filter choke	GT	56B008
CH <sub>2</sub>	Inductor, 4 henries ± 10% d-c resistance 220 ohms ± 10%, iron core, type 10C5	Bass boost choke	ST	55A010
CH <sub>3</sub>	Inductor, universal winding, iron core, designed to resonate at 455KC with 47 mmfd. ± 7% across the coil, type 774	A-N-L wave trap coil	SWI	53B012
J <sub>1</sub>	Jack, single circuit, switching type, single pole double throw, 1 pair contacts normally closed, bushing 3/8-32 x 5/16" long, type 503C	Phonograph pickup connection	U	36B003
J <sub>2</sub>	Jack, switching type, single pole double throw, 1 pair contacts normally closed, bushing 3/8-32 x 3/8" long, type ST-627A	Headphone connection	U	36B011
FS <sub>1</sub>	Fuse, 1.5 amperes @ 250 V., 4AG, glass enclosed, type 1041	A-C line overload protection	LF	39A320
PL <sub>1</sub>	Plug, octal, male, bakelite body, jumpers connect terminals 6 and 7, and terminals 3 and 4, type CP-8	Shorting plug for a-c operation	AP	35A003
PL <sub>2</sub>	Plug and line cord assemble, 2 conductor rubber covered #18 copper stranded wire moulded rubber plug at one end, length 6 feet	Line cord	E	87A078
SO <sub>1</sub>	Socket, octal, female, low loss mica-filled bake- lite insulation, type N1P87	Connection for D-C power supply	AP	6A042
TS <sub>1</sub>	Terminal strip, black bakelite, marked "A <sub>1</sub> " "A <sub>2</sub> " "A <sub>3</sub> ", special	Connection for antenna	H	8A039
TS <sub>2</sub>	Terminal strip, black bakelite, marked "5000", special	Audio output connection for 5,000 ohm load	H	8A040
TS <sub>3</sub>	Terminal strip, black bakelite, marked "500", special	Audio output connection for 500 ohm load	H	8A041

5. LIST OF REPLACEABLE PARTS - (Cont'd.)

REF. SYMBOL	NAME OF PART AND DESCRIPTION	FUNCTION	MFR. CODE	QTY.	QTY. CODE	QTY. PART NO.
W <sub>1</sub>	Water 0.6 milliamperes, 8.8 ohms internal resistance, pointer swing 30 degrees, special 1/8" bracket, special	Carrier level indicator	BE	1	BE	82A07C
CX <sub>1</sub>	Crystal, frequency 455KC ± 5KC, type CEF	Crystal filter	BL	1	BL	19A123
SW <sub>1</sub>	Switch, rotary selector, single section, 3 position, shorting type rotor contacts, bakelite wafer, shaft 2-1/16" long x 1/4" dia. bushing 1/4" deep, type H	Carrier level meter switch	OM	1	OM	60R052
SW <sub>2</sub>	Switch, DPST, toggle action, located on rear of resistor R <sub>55</sub>					
SW <sub>3</sub>	Switch, DPST, bat handle toggle, rated 3 amperes @ 250 V., type 215503A	SEND-RECEIVE switch	HC	1	HC	60A103
SW <sub>4</sub>	Switch, DPST, toggle action, located on the rear of resistor R <sub>53</sub>	A-N-L switch				
SW <sub>5</sub>	Same as SW <sub>1</sub>	A-V-C switch				
SW <sub>6</sub>	Same as SW <sub>1</sub>	A-V-C switch				
SW <sub>7</sub>	Same as SW <sub>1</sub>	Band switch, antenna stage	OM	1	OM	62R025
SW <sub>8-1</sub>	Switch, rotary selector, 7 section, C position, bakelite wafers, sections are assembled to struts, type H	Band switch, r-f amplifier stage	OM	1	OM	62R013
SW <sub>8-2</sub>	Switch, rotary selector, 5 section, 5 position, bakelite wafers, sections are assembled to struts, type 18908-H2					
SW <sub>8-3</sub>	Same as SW <sub>8-5</sub> , SW <sub>8-6</sub> and SW <sub>8-7</sub>					
SW <sub>8-4</sub>	Switch, rotary selector, 5 section, F position, bakelite wafers, sections are assembled to struts type II					
SW <sub>9</sub>	Switch, rotary selector, 2 section, 2 position, bakelite wafers, sections are assembled to struts type II	Band switch, oscillator stage	OM	1	OM	62R015
SW <sub>10</sub>	Switch, rotary selector, single section, 1 position, shorting type rotor contacts, bakelite wafer, type 23886-H	A-V-C switch (ranged with band switch)	OM	1	OM	62I023

G. LIST OF REPLACEABLE PARTS - (Cont'd.)

REF. SYMBOL	NAME OF PART AND DESCRIPTION	FUNCTION	MFR. CODE	CONTR.'S. PART NO.
SW <sub>9-1</sub>	Switch, rotary selector, 3 section, 6 position, shorting type rotor, contacts, bakelite wafers, shaft 2-3/8" long x 1/4" dia., bushing 1/4" deep, type 22659-H3	SELECTIVITY switch	OM	60B048
SW <sub>9-2</sub>				
SW <sub>9-3</sub>				
SW <sub>10</sub>	Switch, SPDT, bat handle toggle, rated 1 ampere @ 250 V. and 3 amperes @ 125 V., type 20994KF	BASS switch	HH	60A102
LM <sub>1</sub>	Lamp 6.3 V. @ 250 milliamperes, bayonet base type 44	Illumination for band spread dial	GE	39A003
LM <sub>2</sub>	Same as LM <sub>1</sub>	Illumination for main tuning dial		
LM <sub>3</sub>	Lamp, 6.3 V. @ 150 milliamperes, bayonet base type 47	Illumination for meter scale	GE	39A004
V <sub>1</sub>	Tube, pentode type 5AB7	R-F amplifier	RCA	90X6AB7
V <sub>2</sub>	Tube, triple-grid super-control amplifier, type 6SK7	R-F amplifier	RCA	90X6SK7
V <sub>3</sub>	Tube, multi-electrode pentagrid converter, type 6SA7	Converter	RCA	90X6SA7
V <sub>4</sub>	Same as V <sub>3</sub>	R-F oscillator		
V <sub>5</sub>	Tube, multi-electrode pentagrid mixer amplifier, type 6L7	I-F amplifier	RCA	90X6L7
V <sub>6</sub>	Same as V <sub>2</sub>	I-F amplifier		
V <sub>7</sub>	Tube, duplex-diode pentode, type 6B8	Detector and meter amplifier	RCA	90X6B8
V <sub>8</sub>	Same as V <sub>7</sub>	A-V-C rectifier and amplifier		
V <sub>9</sub>	Same as V <sub>1</sub>	A-N-L noise amplifier		
V <sub>10</sub>	Tube, twin diode, type 6HA	Noise rectifier and noise peak limiter	RCA	90X6H6
V <sub>11</sub>	Tube, triode, type 6J5	B-F-O	RCA	90X6J5
V <sub>12</sub>	Tube, twin triode, type 6SC7	Audio amplifier and phase inverter	RCA	90X6SC7
V <sub>13</sub>	Tube, beam power amplifier, type 6V6GT	Audio power amplifier	RCA	90X6V6GT
V <sub>14</sub>	Same as V <sub>13</sub>	Audio power amplifier		
V <sub>15</sub>	Tube, full-wave high vacuum rectifier, type 5Z3	Rectifier	RCA	90X5Z3

G. LIST OF REPLACEABLE PARTS - (Cont'd.)

REF. SYMBOL	NAME OF PART AND DESCRIPTION	FUNCTION	MFG. CODE	CONTR.'S. PART NO.
FOR TROPICAL RECEIVERS USE THE ABOVE PARTS LIST EXCEPT FOR THE FOLLOWING ITEMS:				
R31 R32	Resistor, two sections; section #1 (R31) 10,000 ohm ± 10%, 2 watts; section #2 (R32) 4,000 ohm ± 10%, 8 watts; metal clad, wire wound, type MW 5	Voltage divider for screen grids of tubes V2, V3, V5, V6, V7 and V8	IRC	24A822
T3	Transformer, I-F, 455 KC., primary and secondary tuned by adjustable capacitors, fixed iron cores, vacuum impregnated with zophar #1340 and flash dipped in Hallowax #2002, special	Coupling between i-f amplifier tube V6 and diode of 2nd detector tube V7	SWI	50B132
T4	Transformer, 455 KC., tuned by adjustable iron core, winding vacuum wax impregnated and dipped in zophar #1598, special	Beat frequency oscillator inductance	SWI	54B020
T5	Transformer, I-F, 455 KC., primary and secondary tuned by adjustable capacitors, air core, vacuum impregnated with zophar #1340 and flash dipped in Hallowax #2002, trimmers heat cycled at nominal capacity setting (80 mmfd.) and humidity stabilized, special	Coupling between A-N-L tubes V9 and V10	SWI	50B131
T6	Transformer, I-F, 455 KC., primary tuned by adjustable iron core, secondary untuned air core, vacuum impregnated with zophar #1340 and flash dipped in Hallowax #2002, special	Coupling for A-V-C amplifier tube V8	SWI	50B130
T7	Transformer, power, standard; primary, 115 V. A-C, single phase, 50/60 cycles; secondary #1, to provide 290 V. A-C @185 milliamperes with a 5Z3 rectifier and a 30 mfd. input capacitor, center tapped; secondary #2, 6.3 V. A-C @5.5 amperes; secondary #3, 5 V. A-C @3 amperes; windings and core vacuum wax impregnated; transformer potted in a high melting point compound, type 6K64	Filaments and plate power transformer GT	GT	52B045
T8	Transformer, A-F; primary, 10,000 ohm winding, center tapped; secondary, 5000 ohm winding tapped at 500 and 100 ohms, iron core, entire unit dipped in Korite #4, type 3A517	Couples a-f amplifier to load	GT	55B052

6. LIST OF REPLACEABLE PARTS - (Cont'd.)

REF. SYMBOL	NAME OF PART AND DESCRIPTION	FUNCTION	MFG. CODE	CONTIN'S. PART NO.
CH <sub>1</sub>	Inductor, 13 henries, ± 15% @100 milliamperes D-C, d-c resistance 300 ohms ± 10%, iron core, winding impregnated with vacuum wax, entire unit dipped in Korite #4, type 1D34	Plate supply filter choke	CT	56B035
SW <sub>1</sub> SW <sub>2</sub>	Switch, rotary selector, single section, 3 position, shorting type rotor contacts, wax impregnated bakelite wafer, shaft 2-5/16" long x 1/4" dia., bushing 1/4" deep, type H	Carrier level meter switch B-F-O switch	OM	60B144
SW <sub>4</sub>	Switch, SPST, bat handle toggle, rated 3 amperes @250 V., type 8280 15/32 bushing	SEND-RECEIVE switch	CH	60AL38
SW <sub>6</sub> SW <sub>7</sub>	Switch, rotary selector, single section, 3 position, shorting type rotor contacts, wax impregnated bakelite wafer, shaft 2-5/16" long x 1/4" dia., bushing 1/4" deep, type H	A-V-C switch A-V-C switch	OM	60B144
SW <sub>8-1</sub> SW <sub>8-2</sub> SW <sub>8-3</sub> SW <sub>8-4</sub>	Switch, rotary selector, 3 section, 6 position, wax impregnated bakelite wafers, sections are assembled to struts, type H	Band switch, antenna stage	OM	62B033
SW <sub>8-5</sub> SW <sub>8-6</sub> SW <sub>8-7</sub>	Switch, rotary selector, 2 section, 6 position, wax impregnated bakelite wafers, sections are assembled to struts, type H	Band switch, r-f amplifier stage	OM	62B031
SW <sub>8-8</sub> SW <sub>8-9</sub> SW <sub>8-10</sub>	Switch, rotary selector, 2 section, 6 position, wax impregnated bakelite wafers, sections are assembled to struts, type H	Band switch, converter stage	OM	62B031
SW <sub>8-11</sub> SW <sub>8-12</sub> SW <sub>8-13</sub>	Switch, rotary selector, 2 section, 6 position, wax impregnated bakelite wafers, sections are assembled to struts, type H	Band switch, oscillator stage	OM	62B032

G. LIST OF REPLACEABLE PARTS (Cont'd.)

REF. SYMBOL	NAME OF PART AND DESCRIPTION	FUNCTION	MFG. CODE	CONTR'S. PART NO.
SW8-14 SW9-15	Switch, rotary selector, single section, 6 position, wax impregnated bakelite wafer, section is assembled to strut, type H	A-V-C switch(ganged with band switch)	OM	60B135
SW9-1 SW9-2 SW9-3	Switch, rotary selector, 3 section, 6 position, wax impregnated bakelite wafers, shorting type rotor contacts shaft 2-5/8" long x 1/4" dia., bushing 1/4" deep, type H	SELECTIVITY switch	OM	60B134
SW10	Switch, SPDT, bat handle toggle, 3 amperes @125 V., type 8282 15/32 bushing	BASS switch	CH	60A139



## H. INDEX TO PARTS MANUFACTURERS

<u>SYMBOL</u>	<u>MANUFACTURER</u>	<u>SYMBOL</u>	<u>MANUFACTURER</u>
A	Aerovox Corp. New Bedford, Mass.	H	The Hallicrafters Co. Chicago, Illinois
AP	American Phenolic Corp. Cicero, Illinois	HH	Hart & Hegeman Elec. Co. Hartford, Conn.
ASA	Any manufacturer meeting the applicable American Standard Associa- tion specification	IRC	International Resistance Co. Philadelphia, Pa.
BE	Beede Electrical Inst. Co. Penacook, N. H.	LF	Littlefuse Inc. Chicago, Illinois
BL	Bliley Electric Co. Erie, Pa.	OM	Oak Mfg. Co. Chicago, Illinois
CH	Cutler-Hammer Inc. Milwaukee, Wis.	RC	Radio Condenser Camden, N. J.
CM	Chicago Molding Co. Chicago, Illinois	RCA	R. C. A. Mfg. Co. Harrison, N. J.
CRL	Centralab Milwaukee, Wis.	SI	F. W. Sickles Co. Springfield, Mass.
CS	Clarostat Mfg. Co. Brooklyn, N. Y.	SP	Sprague Specialties Co. North Adams, Mass.
CT	Chicago Telephone Supply Co. Elkhart, Ind.	ST	Standard Transformer Corp. Chicago, Illinois
E	Essex Wire Co. Chicago, Illinois	SWI	S. W. Inductor Chicago, Illinois
GE	General Electric Co. Schenectady, N. Y.	U	Utah Radio Products Co. Chicago, Illinois
GT	General Transformer Corp. Chicago, Illinois	UE	Underwood Elec. Co. Chicago, Illinois

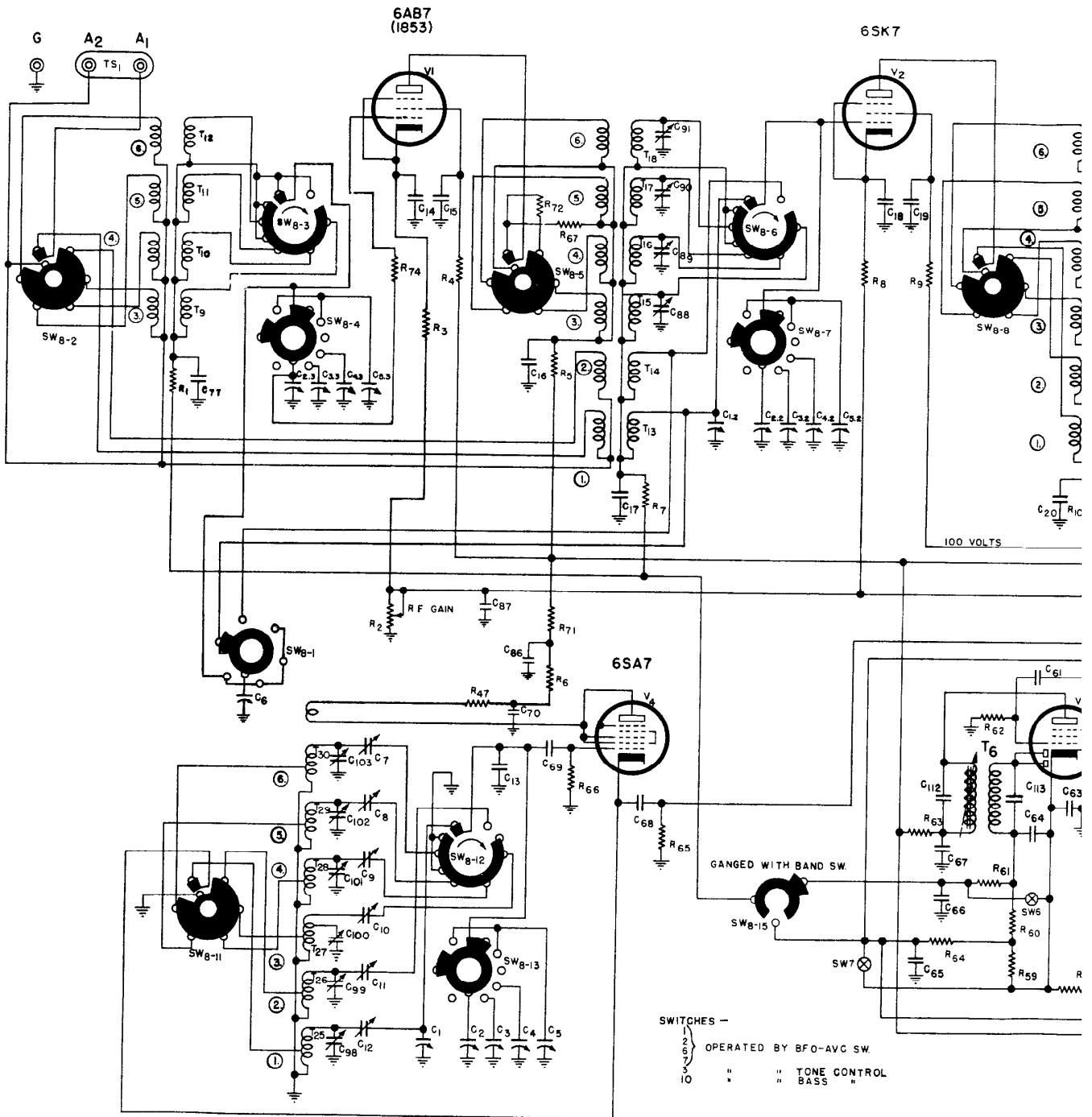

FREQUENCY RANGES

- 1. 0.55 MC. TO 1.6 MC.
- 2. 1.6 MC. TO 3.0 MC.
- 3. 3.0 MC. TO 5.8 MC.
- 4. 5.8 MC. TO 11.0 MC.
- 5. 11.0 MC. TO 21.0 MC.
- 6. 21.0 MC. TO 43.0 MC.

AVC - BFO SWITCH

- |     |      |        |        |
|-----|------|--------|--------|
|     | LEFT | CENTER | RIGHT  |
| SW1 | OPEN | CLOSED | CLOSED |
| SW6 | OPEN | CLOSED | CLOSED |
| SW7 | OPEN | CLOSED | CLOSED |
| SW2 | OPEN | OPEN   | CLOSED |

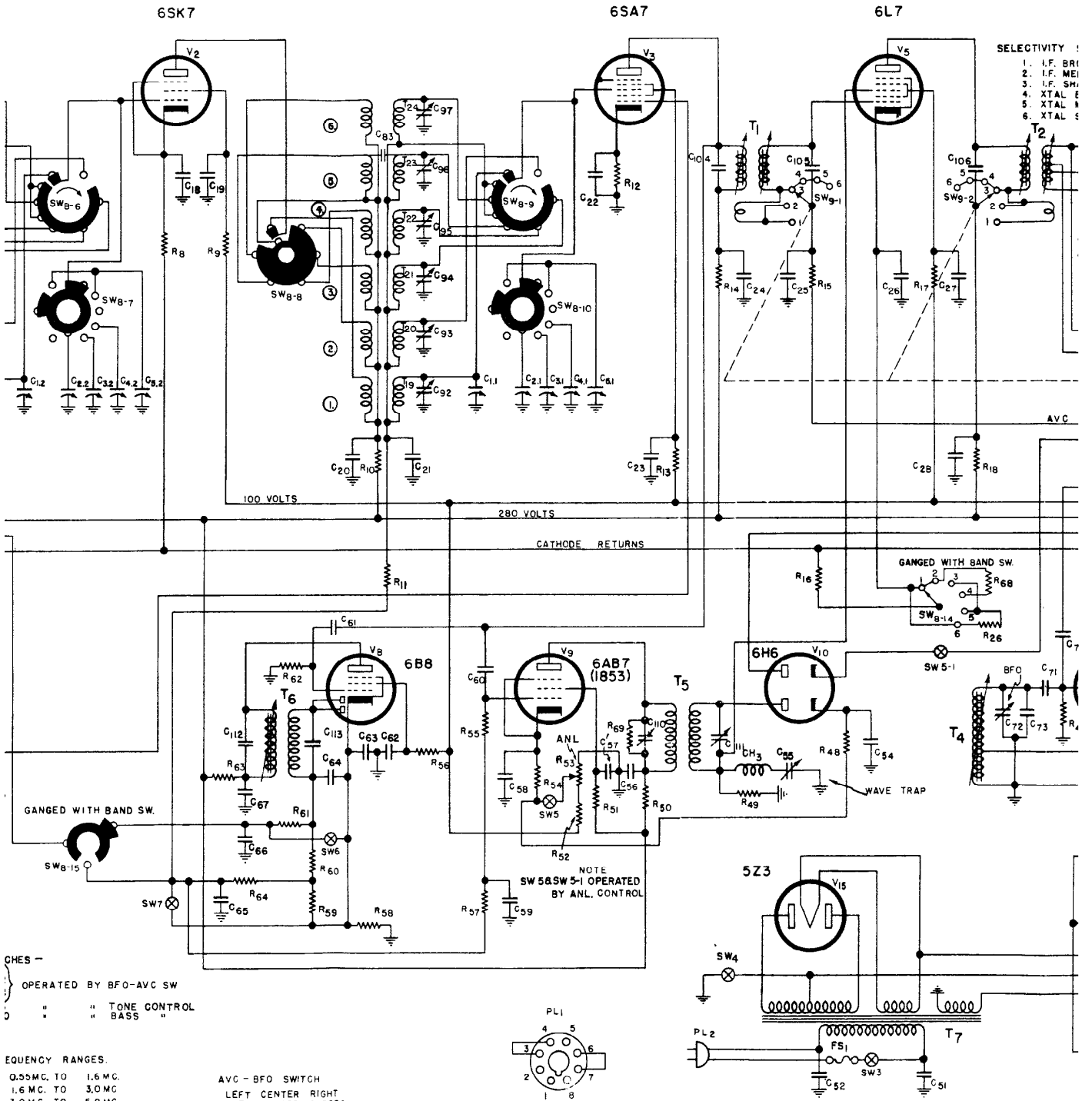

- SELECTIVITY :**
1. I.F. BR1
  2. I.F. ME1
  3. I.F. SW1
  4. XTAL 1
  5. XTAL 2
  6. XTAL 3

CHES -  
 OPERATED BY BFO-AVC SW  
 " " " TONE CONTROL  
 " " " BASS "

**FREQUENCY RANGES.**

0.55 MC. TO 1.6 MC.
1.6 MC. TO 3.0 MC
3.0 MC. TO 5.8 MC
5.8 MC. TO 11.0 MC
11.0 MC. TO 21.0 MC
21.0 MC. TO 43.0 MC

**AVC - BFO SWITCH**

	LEFT	CENTER	RIGHT
SW1	OPEN	CLOSED	CLOSED
SW6	OPEN	CLOSED	CLOSED
SW7	OPEN	CLOSED	CLOSED
SW2	OPEN	OPEN	CLOSED

NOTE  
 SW 5 & SW 5-1 OPERATED  
 BY ANL. CONTROL

SHORTING PLUG WHICH  
 MUST BE IN SOCKET "P"  
 FOR A.C. OPERATION.

FOR D.C. OPERATION CONNECT  
 270 VOLTS + TO PIN 3, -  
 6 " " " TO PIN 7, -

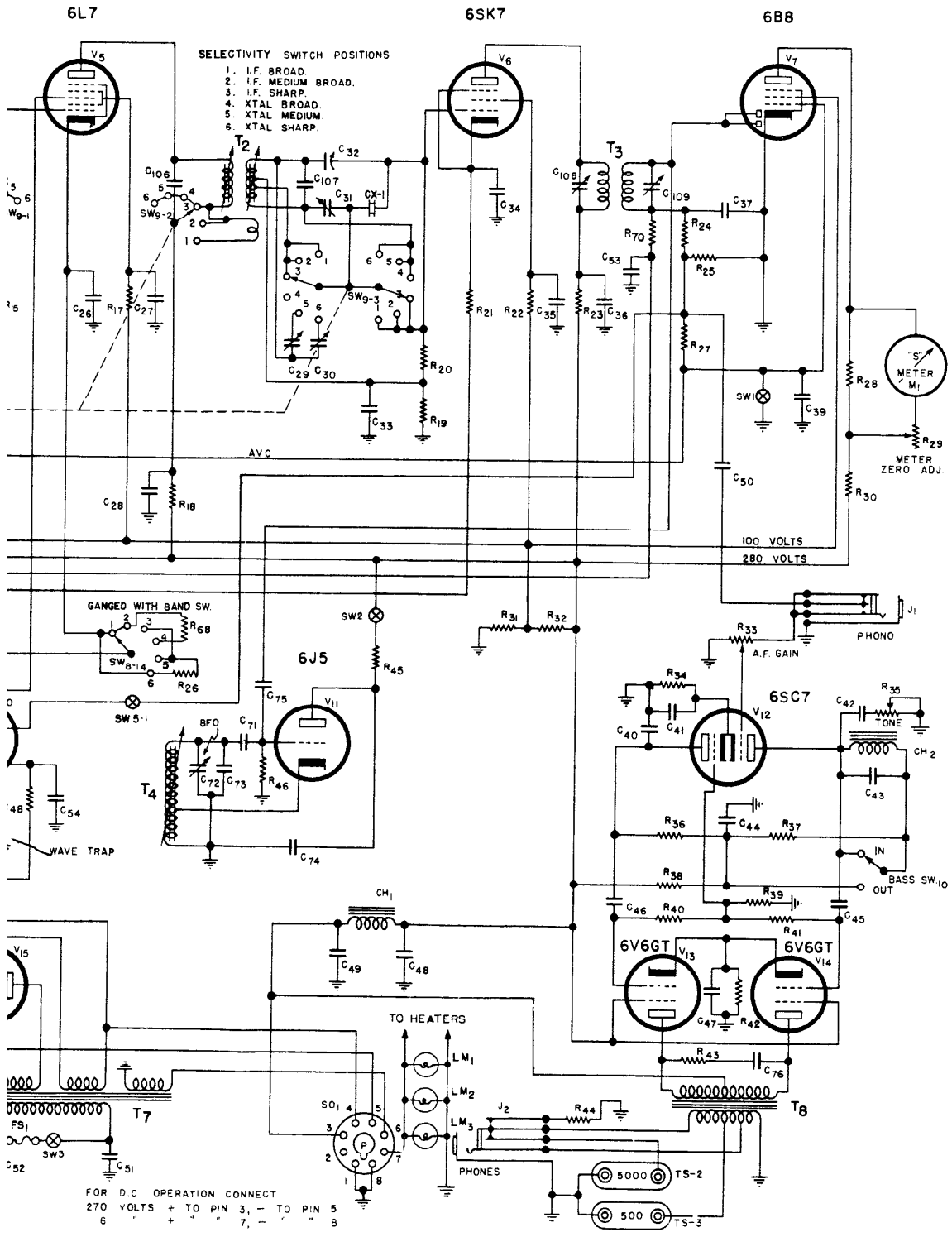

FIG. 13-SX28-A-SCHEMATIC